



Dell UltraSharp 40 Curved Thunderbolt™ Hub Monitor-U4025QW

User's Guide

Model: U4025QW
Regulatory model: U4025QWt



-  **NOTE:** A NOTE indicates important information that helps you make better use of your product.
-  **CAUTION:** A CAUTION indicates either potential damage to hardware or loss of data and tells you how to avoid the problem.
-  **WARNING:** A WARNING indicates a potential for property damage, personal injury, or death.

Copyright © 2024 Dell Inc. or its subsidiaries. All rights reserved. Dell, EMC, and other trademarks are trademarks of Dell Inc. or its subsidiaries. Other trademarks may be trademarks of their respective owners.

2024 – 02

Rev. A00

Contents

Safety instructions	5
About your monitor	6
Package contents	6
Product features	7
Operating system compatibility	12
Identifying parts and controls	13
Front view	13
Top view	14
Back view	15
Bottom view	16
Monitor specifications	18
Resolution specifications	20
Preset display modes	20
Thunderbolt™ 4 out for daisy chain	21
Electrical specifications	22
Speaker specifications	23
Physical characteristics	23
Environmental characteristics	25
Monitor resolution for daisy chain setup	26
Thunderbolt™ video resolution	27
HDMI video resolution	27
DP video resolution	27
Pin assignments	28
Plug-and-Play capability	36
LCD monitor quality and pixel policy	36
Ergonomics	37
Handling and moving your display	38
Maintenance guidelines	40
Cleaning your monitor	40
Setting up the monitor	41
Attaching the stand	41
Using the tilt, swivel, and vertical extension	44



Tilt, swivel, and vertical extension44
Organizing your cables	44
Connecting your monitor	45
Dell Power Button Sync (DPBS)	51
Connecting the monitor for DPBS for the first time54
Using DPBS function55
Connecting the monitor for Thunderbolt™ daisy chain function57
Connect multiple Thunderbolt™ 4 monitors to one system58
Securing your monitor using Kensington lock (optional)	60
Removing the monitor stand	61
Wall mounting (Optional)	62
Operating the monitor	63
Power on the monitor	63
Using the joystick control	63
Enable Menu Voice function	64
Using the rear-panel controls	65
Front-panel button66
Using the Main Menu	67
Using the OSD lock function	88
Initial Setup91
OSD warning messages92
Setting the maximum resolution95
Troubleshooting	96
Self-test	96
Built-in diagnostics	97
Common Problems	98
Product-specific problems102
Universal Serial Bus (USB) specific problems105
Regulatory information	106
FCC notices (U.S. only) and other regulatory information106
EU product database for energy label and product information sheet106
Contacting Dell	107



Safety instructions

Use the following safety guidelines to protect your monitor from potential damage and to ensure your personal safety. Unless otherwise noted, each procedure included in this document assumes that you have read the safety information that shipped with your monitor.



NOTE: Before using the monitor, read the safety information that is shipped with your monitor and printed on the product. Keep the documentation at a secure location for future reference.

⚠ WARNING: Use of controls, adjustments, or procedures other than those specified in this documentation may result in exposure to shock, electrical hazards, and/or mechanical hazards.

⚠ WARNING: The possible long-term effect of listening to audio at high volume through the headphones (on monitor that support it) may cause damage to your hearing ability.

- Place the monitor on a solid surface and handle it carefully. The screen is fragile and can be damaged if dropped or hit with a sharp object.
- Ensure that your monitor is electrically rated to operate with the AC power available in your location.
- Keep the monitor in room temperature. Excessive cold or hot conditions can have an adverse effect on the liquid crystals of the display.
- Connect the power cable from the monitor to a wall outlet that is near and accessible. See [Connecting your monitor](#).
- Do not place and use the monitor on a wet surface or near water.
- Do not subject the monitor to severe vibration or high impact conditions. For example, do not place the monitor inside a car trunk.
- Unplug the monitor when it is going to be left unused for an extended period.
- To avoid electric shock, do not attempt to remove any cover or touch internal part of the monitor.
- Read these instructions carefully. Keep this document for future reference. Follow all warnings and instructions marked on the product.
- Certain monitors can be wall mounted using the VESA mount that is sold separately. Ensure to use the correct VESA specifications as mentioned in the wall mounting section of the User's Guide.

For information on safety instructions, see the Safety, Environmental, and Regulatory Information (SERI) document that is shipped with your monitor.









About your monitor

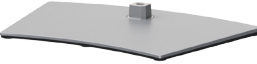

Package contents

The following table provides the list of components that are shipped with your monitor. If any component is missing, contact Dell. For more information, see [Contact Dell](#).

 **NOTE: Some items may be optional and may not ship with your monitor. Some features may not be available in certain countries.**

Component image	Component description
	Display
	Stand riser
	Stand base
	Power cable (varies by country or region)
	DisplayPort 1.4 cable (DisplayPort to DisplayPort) Cable length - 1.8 M
	USB Type-A to USB Type-C Gen2 cable (Enables USB ports on the monitor) Cable length - 1 M



	HDMI 2.1 cable Cable length - 1.8 M
	Thunderbolt™ 4 Active cable Cable length - 1.5 M
	<ul style="list-style-type: none"> • Quick Setup Guide • Safety, Environmental, and Regulatory Information • Factory Calibration Report

Product features

The **Dell UltraSharp U4025QW** monitor has an active matrix, Thin-Film Transistor (TFT), Liquid Crystal Display (LCD), and LED backlight. The monitor features include:

- 100.859 cm (39.7 in.) active area display (Measured diagonally) 5120 x 2160 (21:9) resolution, plus full-screen support for lower resolutions.
- Wide viewing angles with 100% sRGB color, 99% DCI-P3, 100% BT.709 & 99% Display P3.
- Tilt, swivel, and vertical extension adjustment capabilities.
- Integrated speakers (2 x 9 W).
- Removable pedestal stand and Video Electronics Standards Association (VESA™) 100 mm mounting holes for flexible mounting solutions.
- Ultra-thin bezel minimizes the bezel gap during multi-monitor usage, enabling easier setup with an elegant viewing experience.
- Digital connectivity with DisplayPort, Thunderbolt™ and HDMI (supports up to 5K2K 5120 x 2160 120Hz FRL, HDR Static Metadata, VRR as per specified in HDMI 2.1.).
- Thunderbolt™ 4 ports to supply power for compatible notebook up to 140 W while receiving Video and USB signal.
- Thunderbolt™ 4 and RJ45 ports enable a single-cable, network-connected experience.
- Plug and play capability if supported by your computer.
- On-Screen Display (OSD) adjustments for ease of set-up and screen optimization.
- Power and OSD buttons lock.
- Security lock slot.
- Stand lock.



- Power consumption ≤ 0.3 W in Standby Mode (DisplayPort or HDMI port and without upstream port connector).
- This monitor supports VRR (Variable refresh rate) function, get higher frame rates and help reduce screen tearing in games.
- This monitor supports DRR (Dynamic refresh rate) function. DRR works with Windows 11, allowing you to experience smoother text scroll and mouse cursor movement.
- Supports Dell Text to Speech (English) device.
- Supports Picture by Picture (PBP) and Picture in Picture (PIP) Select mode.
- Supports internal Multi-Stream Transport (MST) function (Screen Partition item in OSD) for DP port and Thunderbolt™ 4 (Video + Data).
- Allows you to switch USB KVM function in PBP/PIP mode.
- The monitor is designed with a Dell Power Button Sync (DPBS) feature to control PC system power state from a monitor power button.*

*Dell system that supports DPBS is listed in the Dell website. DPBS function can be enabled in the OSD menu under Display.

- Premium Panel Exchange for peace of mind.
- Optimize eye comfort with a flicker-free screen and low blue light feature to minimizes hazard blue light emission.
- Dell ComfortView Plus is an integrated low blue light screen feature that improves eye comfort by reducing potentially harmful blue light emissions without compromising color. Through ComfortView Plus technology, Dell has reduced harmful blue light exposure from $\leq 50\%$ to $\leq 35\%$. This monitor is certified with TÜV Rheinland Eye Comfort 3.0 with a 5-star rating. It incorporates key technologies that also deliver a flicker-free screen, up to 120 Hz refresh rate, a color gamut of minimum 95% DCI-P3, color accuracy, and ambient light sensor performance. Dell ComfortView Plus feature is enabled by default on your monitor.
- This monitor uses a low blue light panel. When the monitor is reset to factory settings or default setting, it is in compliance with TÜV Rheinland's hardware low blue light certification.**

Blue light ratio:

The ratio of light in the range from 415nm-455nm compared to 400nm-500nm shall be less than 50%.

Category	Blue light ratio
1	$\leq 20\%$
2	$20\% < R \leq 35\%$
3	$35\% < R \leq 50\%$



- Decreases the level of hazard blue light emitted from the screen to make viewing more comfortable for your eyes without distortion of color accuracy.
- The Monitor adopts Flicker-Free technology, which clears the eye visible flicker, brings comfort viewing experience and preventing users suffer from eye strain and fatigue.

* For Dell systems that support this feature.

** This monitor is in compliance with TÜV Rheinland hardware low blue light certification under Category 2.



About TÜV Rheinland Eye Comfort 3.0

TÜV Rheinland Eye Comfort 3.0 certification program presents a consumer-friendly star rating scheme to the display industry promoting eye wellness from safety to eye care. Compared to existing certifications, the 5-star-rating program adds rigorous testing requirements on overall eye care attributes such as low blue-light, flicker-free, refresh rate, color gamut, color accuracy and ambient light sensor performance. It lays out requirement metrics and rates the product performance on five levels, and the sophisticated technical assessment process provides consumers and buyers with indicators that are easier to judge.

The eye wellness factors being considered remain constant, however, the standards for the various star ratings are different. The higher the star rating, the more stringent the standards. The table below lists the major eye comfort requirements which apply in addition to the basic eye comfort requirements (such as pixel density, uniformity of luminance and color, and freedom of movement).

For more information around **TÜV Eye Comfort certification** please refer to: <https://www.tuv.com/world/en/eye-comfort.html>



Eye Comfort 3.0 Requirements and Star Rating Scheme for Monitors

Category	Test item	Star Rating Scheme		
		3-star	4-star	5-star
Eye Care	Low Blue Light	TÜV Hardware LBL Category III ($\leq 50\%$) or Software LBL solution ¹	TÜV Hardware LBL Category II ($\leq 35\%$) or Category I ($\leq 20\%$)	TÜV Hardware LBL Category II ($\leq 35\%$) or Category I ($\leq 20\%$)
	Flicker Free	TÜV Flicker Reduced or TÜV Flicker Free	TÜV Flicker Reduced or TÜV Flicker Free	Flicker Free
Ambient Light Management	Ambient Light Sensor performance	No sensor	No sensor	Ambient light sensor
	Intelligent CCT control	No	No	Yes
	Intelligent Luminance control	No	No	Yes
Image quality	Refresh Rate	$\geq 60\text{Hz}$	$\geq 75\text{Hz}$	$\geq 120\text{Hz}$
	Luminance uniformity	Luminance uniformity $\geq 75\%$		
	Color Uniformity	Color uniformity $\Delta u'v' \leq 0.02$		
	Freedom of movement	Luminance changes shall decrease less than 50%; The colour shift shall be less than 0.01		
	Gamma difference	Gamma difference $\leq \pm 0.2$	Gamma difference $\leq \pm 0.2$	Gamma difference $\leq \pm 0.2$
	Wide color gamut ²	NTSC ³ Min.72% (CIE 1931) or sRGB ⁴ Min 95% (CIE 1931)	sRGB ⁴ Min.95% (CIE 1931)	DCI-P3 ⁵ Min. 95% (CIE 1976) & sRGB ⁴ Min.95% (CIE 1931) or Adobe RGB ⁶ Min.95% (CIE 1931) & sRGB ⁴ Min.95% (CIE 1931)
Eye Comfort User Guide	User guide	Yes	Yes	Yes
Remark	<p>¹ Software controls the blue light emission by reducing excessive blue light, resulting in a more yellow tone.</p> <p>² Color gamut describes the availability of colors in the display. Various standards were developed for specific purposes. 100% corresponds to the full color space as defined in the standard.</p> <p>³ NTSC stands for National Television Standards Committee, which developed a color space for the television system that is used in the United States.</p> <p>⁴ sRGB is a standard red, green, and blue color space that is in use on monitors, printers, and the World Wide Web.</p> <p>⁵ DCI-P3, short for Digital Cinema Initiatives - Protocol 3, is a color space used in digital cinema that encompasses a wider range of colors than the standard RGB color space.</p> <p>⁶ Adobe RGB is a color space created by Adobe Systems that encompasses a broader range of colors than the standard RGB color model, particularly in the cyans and greens.</p>			



Operating system compatibility

- Windows 10 and later*
- macOS 12* and macOS 13*

*The operating system compatibility on Dell and Alienware branded monitors may vary based on factors such as:



- Specific release date(s) when operating system versions, patches, or updates are available.
- Specific release date(s) when Dell and Alienware branded monitor firmware, software application, or driver updates are available on the Dell support website.

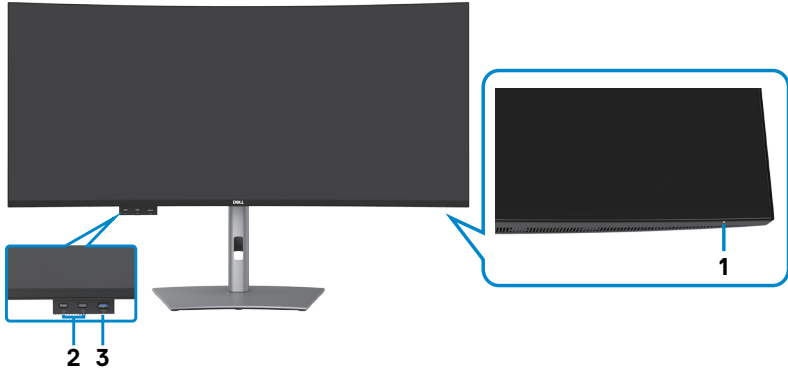

Identifying parts and controls

Front view



Label	Description	Use
1	Power LED indicator	Solid white light indicates that the monitor is turned on and functioning as expected. Breathing white light indicates that monitor is in Standby Mode.
2	2 x USB Type-C [®] downstream port (SuperSpeed USB 10 Gbps, USB 3.2 Gen2) with power charging (15W)	Connect your USB device. Port with  icon supports 5 V/ 3 A.
3	USB Type-A downstream port (SuperSpeed USB 10 Gbps, USB 3.2 Gen2) with BC1.2 5 V/1.5 A typical (2 A max) power charging	Connect your USB device. Port with  battery icon supports Battery Charging Rev. 1.2.

 **NOTE: You can use this port only after you have connected the USB cable (A to C or C to C) to the USB-C[®] upstream port at the rear of the monitor to the PC.**

 **NOTE: USB Type-C[®] and USB-C[®] are registered trademarks of the USB Implementers Forum.**



Top view

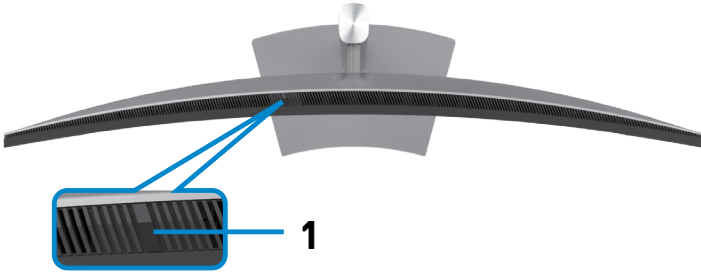

Label	Description	Use
1	Ambient Light Sensor	Detects ambient light and adjusts the brightness of the display accordingly. For more information, see Auto Brightness . NOTE: If the Ambient Light Sensor detects an abnormal change in the light level, see The detected light level drops significantly .



Back view







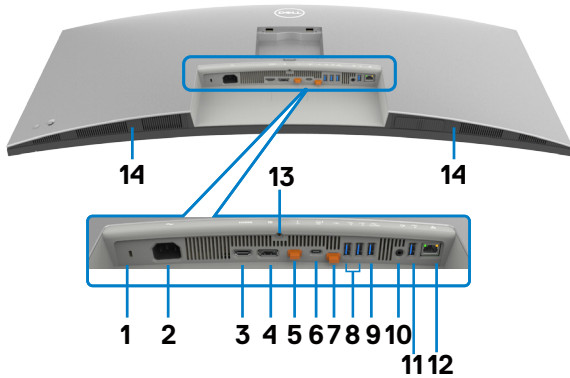

Label	Description	Use
1	VESA mounting holes (100 mm x 100 mm-behind attached VESA cover)	Wall-mount monitor using VESA-compatible wall mount kit (100 mm x 100 mm).
2	Regulatory label	Lists the regulatory approvals.
3	Stand release button	Releases stand from the monitor.
4	Power button	To turn the monitor on or off.
5	Joystick	Use it to control the OSD menu. For more information, see Operating the Monitor .
6	Mac address, Barcode, serial number, and Service Tag label	See this label if you need to contact Dell for technical support. The Service Tag is a unique alphanumeric identifier that enables Dell service technicians to identify the hardware components in your computer and access warranty information.
7	Cable-management slot	Use to organize cables by inserting them through the slot.









Bottom view



Label	Description	Use
1	Security lock slot (based on Kensington Security Slot™)	Secures monitor with security cable lock (sold separately).
2	 Power connector	Connect the power cable.
3	 HDMI 2.1	Connect your computer with the HDMI cable.
4	 DisplayPort in	Connect your computer with the DisplayPort cable.
5	  Thunderbolt™ 4 downstream port (15W) for daisy chaining (Video + Data) 	Thunderbolt™ 4 downstream ports used only for daisy chain to another monitor with Thunderbolt™ or USB-C® cable. NOTE: 1) Thunderbolt™ 4 up to 40 Gbps bandwidth; 2) Supports up to two 5K monitors through the Daisy chain; 3) The highest power output is up to 15 W or 5 V/3 A. NOTE: Remove the rubber plug when using Thunderbolt™ 4 downstream connector.



<p>6</p>	 <p>Thunderbolt™ 4 upstream port (Video + Data). Alternate mode with DisplayPort 1.4, Power Delivery up to 140W</p>	<p>Connect to your computer using the Thunderbolt™ cable.</p> <p>The Thunderbolt™ 4 upstream enable the following features:</p> <ul style="list-style-type: none"> a) Dynamically allocate 40 Gbps of bandwidth for USB signal and Alt-DP video. b) Maximum resolution of 5120 x 2160 at 120 Hz with Alt-DP 1.4 DSC video source. c) Maximum USB PD up to 140 W. <p>NOTE: If Thunderbolt™ upstream power is more than 100 W, the connected equipment and accessory cables should have fire enclosure of V1 level or higher and VW-1 rating wire.</p> <p>NOTE: Thunderbolt™ 4 upstream is not supported on Windows versions that are prior to Windows 10.</p> <p>CAUTION: A reduced performance warning message may appear when connecting monitor's Thunderbolt™ 4 port to USB Type-C port of computer. To optimize performance, recommended to connect to computer's Thunderbolt™ 4 port.</p>
<p>7</p>	 <p>USB Type-C® upstream port (SuperSpeed USB 10 Gbps, USB 3.2 Gen2) (data only)</p> 	<p>Connect the USB-C to A cable that comes with your monitor to the computer. This cable is needed when HDMI or DP video is in use. It is to enable USB communication between the Monitor downstream devices and the host.</p> <p>NOTE: Remove the rubber plug when using USB-C® upstream connector.</p>
<p>8,9,11</p>	 <p>USB Type-A downstream port (SuperSpeed USB 10 Gbps, USB 3.2 Gen2) (4)</p>	<p>Connect your USB device. You can use these ports only after you have connected the USB cable from the computer to the monitor.</p> <p>The port with  icon supports Menu Voice function.</p>
<p>10</p>	 <p>Audio line-out</p>	<p>Connect speakers to playback audio through HDMI or DisplayPort audio channels.</p> <p>Only two-channel audio is supported.</p> <p>NOTE: The audio line-out port does not support headphones.</p>



12	 RJ45 port	Connect to Ethernet router with RJ45 cable. To enable network access, either USB-C® or Thunderbolt™ 4 upstream port must be connected to the host computer with an appropriate cable mentioned above.
13	Stand lock	Lock the stand to the monitor using a M3 x 8 mm screw (screw not included).
14	Built-in speakers	To output the sound from an audio input.

 **NOTE: Thunderbolt™ is a trademark of Intel Corporation.**

Monitor specifications

Screen type	Active matrix - TFT LCD
Panel Type	In-plane switching Technology
Aspect ratio	21:9
Viewable image dimensions	
Diagonal	1008.59 mm (39.7 in.)
Active Area	
Horizontal	929.28 mm (36.59 in.)
Vertical	392.04 mm (15.43 in.)
Area	364314.9 mm ² (564.69 in. ²)
Pixel pitch	0.1815 mm x 0.1815 mm
Pixel per inch (PPI)	140
Viewing angle	
Horizontal	178° (typical)
Vertical	178° (typical)
Brightness	450 cd/m ² (typical) 600 cd/m ² (HDR Peak)
Contrast ratio	2000 to 1 (typical)
Curvature	2500R
Display screen coating	Anti-Glare with 3H hardness
Backlight	LED Edgelight System
Response Time (Gray to Gray)	5 ms (Fast mode) 8 ms (Normal mode)



Color depth	1.07 Billion colors (8bit + A-FRC)*
Color gamut**	sRGB 100% BT.709 100% DCI-P3 99% Display P3 99%
Calibration accuracy	DCI-P3, Display P3, sRGB & BT.709: Delta E < 2 (Average)
Connectivity	<ul style="list-style-type: none"> • 1 x HDMI (supports up to 5K2K 5120 x 2160 120Hz FRL, HDR Static Metadata, VRR as per specified in HDMI 2.1.) • 1 x DP 1.4 (HDCP 2.3) (Support up to 5120 x 2160 120Hz, HDR, DSC) • 1 x Thunderbolt™ 4 downstream port (15 W) for daisy chaining (Video + Data) • 1 x Thunderbolt™ 4 (140 W) (Alternate mode with DisplayPort 1.4, SuperSpeed USB 3.2 Gen2 (10 Gbps) upstream port, USB Power Delivery up to 140 W) • 1 x USB Type-C® upstream port (data only) (SuperSpeed USB 10 Gbps, USB 3.2 Gen2) • 4 x USB Type-A downstream port (SuperSpeed USB 10 Gbps, USB 3.2 Gen2) • 1 x Audio line-out • 1 x RJ45 (2.5GbE) <p>Quick Access:</p> <ul style="list-style-type: none"> • 1 x USB Type-A downstream port (SuperSpeed USB 10 Gbps, USB 3.2 Gen2) with BC1.2 power charging • 2 x USB Type-C® downstream port (SuperSpeed USB 10 Gbps, USB 3.2 Gen2) with power charging (15W)
Border width (edge of monitor to active area)	
Top	11.30 mm
Left/Right	11.30 mm
Bottom	15.80 mm
Adjustability	
Height adjustable stand	150 mm
Tilt	-5° to 21°
Swivel	-30° to 30°



 **NOTE: Do not mount or use this monitor in portrait (vertical) orientation or inverse (180°) landscape mount as it may damage the monitor.**

Cable management	Yes
Dell Display Manager (DDM)Compatibility	Easy Arrange and other key features
Security	Security lock slot (cable lock sold separately)

*The monitor is capable of producing 1.07 billion colors at maximum resolution 5120 x 2160 @ 120 Hz with DP 1.4 DSC, Thunderbolt™ ALT-DP 1.4 DSC or HDMI 2.1 Video source.

** At panel native only, under Color Space preset.

Resolution specifications

Horizontal scan range	25 kHz to 280 kHz
Vertical scan range	48 Hz to 120 Hz
Maximum preset resolution	5120 x 2160 at 120 Hz
Video display capabilities (HDMI & DP & Thunderbolt™ 4 (140 W) alternate mode)	480p, 560p, 720p, 1080p

Preset display modes

Display mode	Horizontal frequency (kHz)	Vertical frequency (Hz)	Pixel clock (MHz)	Sync polarity (Horizontal/Vertical)
VESA, 720 x 400	31.50	70.00	28.30	-/+
VESA, 640 x 480	31.50	60.00	25.20	-/-
VESA, 640 x 480	37.50	75.00	31.50	-/-
VESA, 800 x 600	37.90	60.30	40.00	+/+
VESA, 800 x 600	46.90	75.00	49.50	+/+
VESA, 1024 x 768	48.40	60.00	65.00	-/-
VESA, 1024 x 768	60.00	75.00	78.80	+/+
VESA, 1152 x 864	67.50	75.00	108.00	+/+
VESA, 1280 x 800	49.70	60.00	83.50	+/+
VESA, 1280 x 1024	64.00	60.00	108.00	+/+
VESA, 1280 x 1024	80.00	75.00	135.00	+/+
VESA, 1600 x 1200	75.00	60.00	162.00	+/+



VESA, 1680 x 1050	65.29	60.00	146.25	-/+
VESA, 1920 x 1080	67.50	60.00	148.50	+/+
VESA, 1920 x 1200	74.04	60.00	154.00	+/-
VESA, 2048 x 1152	70.99	60.00	156.75	+/-
VESA, 2048 x 1280	78.92	60.00	174.25	+/-
VESA, 2560 x 1080	66.64	60.00	181.25	+/-
VESA, 1024 x 2160	133.24	60.00	157.75	+/-
VESA, 1280 x 2160	133.15	60.00	191.75	+/-
VESA, 2560 x 2160	133.27	60.00	362.50	+/-
VESA, 3840 x 2160	65.58	30.00	262.75	+/-
VESA, 3840 x 2160	135.00	60.00	594.00	+/-
VESA, 3840 x 2160	133.31	60.00	533.25	+/-
VESA, 4096 x 2160	65.67	30.00	279.50	+/-
VESA, 4096 x 2160	133.28	60.00	567.25	+/-
VESA, 5120 x 2160	65.73	30.00	347.06	+/-
VESA, 5120 x 2160	133.32	60.00	703.93	+/-
VESA, 5120 x 2160	270.00	120.00	1485.0	+/+

Thunderbolt™ 4 out for daisy chain

OSD Display Info: Link rate(current)	Maximum external monitor resolution that can be supported 5120 x 2160 at 120 Hz
---	--

 **NOTE: The Maximum resolution of 5120 x 2160 at 120Hz can only be produced with Thunderbolt™ DP-ALT 1.4 DSC, DP 1.4 DSC, or HDMI 2.1 video source.**



Electrical specifications

Video input signals	<ul style="list-style-type: none"> · Digital video signal for each differential line Per differential line at 100 ohm impedance · DP/HDMI/Thunderbolt™ 4 (140 W) signal input support
Input voltage/ frequency/current	100-240 VAC/50 Hz or 60 Hz ± 3 Hz/4.2 A (typical)
Inrush current	120 V: 42 A (Max.) 240 V: 80 A (Max.) Inrush current is measured at an ambient temperature of 0°C.
Power consumption	0.3 W (Off Mode) ¹ 0.4 W (Standby Mode) ¹ 1.8 W (Networked standby Mode) ¹ 39.5 W (On Mode) ¹ 380 W (Max) ² 45 W (P_{on}) ³ 153.6 kWh (TEC) ³

¹As defined in EU 2019/2021 and EU 2019/2013.

²Max brightness and contrast setting with maximum power loading on all USB ports.

³ P_{on} : Power consumption of On Mode as defined in Energy Star 8.0 version.

TEC: Total energy consumption in kWh as defined in Energy star 8.0 version.

This document is informational only and reflects laboratory performance. Your product may perform differently, depending on the software, components, and peripherals you ordered and shall have no obligation to update such information. Accordingly, the customer should not rely upon this information in making decisions about electrical tolerances or otherwise. No warranty as to accuracy or completeness is expressed or implied.

 **NOTE: This monitor is ENERGY STAR certified.**





This product qualifies for ENERGY STAR in the factory default settings which can be restored by “Factory Reset” function in the OSD menu. Changing the factory default settings or enabling other features may increase power consumption that could exceed the ENERGY STAR specified limit.



Speaker specifications

Speaker rated power	2 x 9 W
Frequency response	100 Hz - 20 kHz
Impedance	8 ohm

Physical characteristics

Connector type	<ul style="list-style-type: none"> • DP connector (in) • HDMI connector • Thunderbolt™ 4 upstream connector • Thunderbolt™ 4 downstream connector • USB Type-C® upstream connector • Audio line-out • RJ45 connector • USB Type-C® downstream connector x 2 (Port with  icon supports 5 V/3 A) • SuperSpeed USB Type-A 3.2 Gen2 downstream port x 5 (Port with  battery icon supports BC 1.2.) (Port with  icon supports Menu Voice function.)
Signal cable type	<ul style="list-style-type: none"> • DP to DP cable (cable length - 1.8 M) • HDMI cable (cable length - 1.8 M) • USB Type-A to USB Type-C Gen2 cable (cable length - 1 M) • Thunderbolt™ 4 Active cable (cable length - 1.5 M)
Dimensions (with stand)	
Height (extended)	622.32 mm (24.50 in.)
Height (compressed)	472.32 mm (18.60 in.)
Width	946.62 mm (37.27 in.)
Depth	252.80 mm (9.95 in.)
Dimensions (without stand)	
Height	419.14 mm (16.50 in.)
Width	946.62 mm (37.27 in.)
Depth	108.04 mm (4.25 in.)
Stand dimensions	



Height (extended)	483.30 mm (19.03 in.)
Height (compressed)	436.50 mm (17.19 in.)
Width	391.50 mm (15.37 in.)
Depth	252.80 mm (9.95 in.)
Weight	
Weight with packaging	19.02 kg (41.93 lb)
Weight with stand assembly and cables	12.22 kg (26.94 lb)
Weight without stand assembly (For wall mount or VESA mount considerations - no cables)	8.35 kg (18.41 lb)
Weight of stand assembly	3.38 kg (7.45 lb)



Environmental characteristics

Compliant Standards	
<ul style="list-style-type: none">• ENERGY STAR certified Monitor.• EPEAT registered where applicable. EPEAT registration varies by country. See https://www.epeat.net for registration status by country.• TCO Certified & TCO Certified Edge.• RoHS Compliant.• BFR/PVC Free monitor (excluding external cables).• Meets NFPA 99 leakage current requirements.• Arsenic-Free glass and Mercury-Free for the panel only.	
Temperature	
Operating	0°C to 40°C (32°F to 104°F)
Non-operating	-20°C to 60°C (-4°F to 140°F)
Humidity	
Operating	10% to 80% (non-condensing)
Non-operating	5% to 90% (non-condensing)
Altitude	
Operating	5,000 m (16,404 ft) (maximum)
Non-operating	12,192 m (40,000 ft) (maximum)
Thermal dissipation	1296.6 BTU/hour (maximum) 134.8 BTU/hour (On Mode)



Monitor resolution for daisy chain setup

Host Capability	Cable type used on Thunderbolt™ 4 upstream port	Maximum resolution for primary monitor	Cable type used on Thunderbolt™ 4 downstream port	Maximum resolution for Secondary monitor
TBT4 (Alt Mode DP 1.4 DSC enabled)	Thunderbolt™ 4 Active cable	5120 x 2160 @ 120 Hz	Thunderbolt™ 4 Active cable	5120 x 2160 @ 120 Hz
TBT3 (Alt Mode DP 1.2)	Thunderbolt™ 4 Active cable	5120 x 2160 @ 30 Hz	Thunderbolt™ 4 Active cable	5120 x 2160 @ 30 Hz
TBT4 (Alt Mode DP 1.4 DSC enabled)	Thunderbolt™ 4 Active cable	5120 x 2160 @ 120 Hz	USB Type C-C Cable	5120 x 2160 @ 120 Hz
TBT3 (Alt Mode DP 1.2)	Thunderbolt™ 4 Active cable	5120 x 2160 @ 30 Hz	USB Type C-C Cable	5120 x 2160 @ 30 Hz
TBT4 (Alt Mode DP 1.4 DSC enabled)	USB Type C-C Cable	5120 x 2160 @ 120 Hz	NA	Not supported
TBT3 (Alt Mode DP 1.2)	USB Type C-C Cable	5120 x 2160 @ 30 Hz	NA	Not supported
USB-C (Alt Mode DP 1.4 DSC enabled)	Thunderbolt™ 4 Active cable	5120 x 2160 @ 120 Hz	NA	Not supported
USB-C (Alt Mode DP 1.2)	Thunderbolt™ 4 Active cable	5120 x 2160 @ 30 Hz	NA	Not supported
USB-C (Alt Mode DP 1.4 DSC enabled)	USB Type C-C Cable	5120 x 2160 @ 120 Hz	NA	Not supported
USB-C (Alt Mode DP 1.2)	USB Type C-C Cable	5120 x 2160 @ 30 Hz	NA	Not supported

 **NOTE: Monitor daisy chain only via Thunderbolt™ port.**

 **NOTE: Set the OSD for “Thunderbolt Daisy Chain” to “Optimized” to get 5120 x2160 @120Hz on both the monitors.**

 **NOTE: If TBT out cannot display, please refer to [Troubleshooting TBT out cannot display](#).**



Thunderbolt™ video resolution

Host Capability	Maximum Resolution
TBT4 (Alt Mode DP 1.4 DSC enabled)	5120 x 2160 @ 120 Hz
TBT4 (Alt Mode DP 1.4)	5120 x 2160 @ 60 Hz
TBT3 (Alt Mode DP 1.2)	5120 x 2160 @ 30 Hz
USB-C (Alt Mode DP 1.4 DSC enabled)	5120 x 2160 @ 120 Hz
USB-C (Alt Mode DP 1.4)	5120 x 2160 @ 60 Hz
USB-C (Alt Mode DP 1.2)	5120 x 2160 @ 30 Hz

HDMI video resolution

Host Capability	Maximum Resolution
HDMI 1.4	3840 x 2160 @ 30 Hz
HDMI 2.0	5120 x 2160 @ 30 Hz/4096 x 2160 @ 60 Hz
HDMI 2.1	5120 x 2160 @ 120 Hz

DP video resolution

Host Capability	Maximum Resolution
8.1G 4-Lane DSC	5120 x 2160 @ 120 Hz
8.1G 4-Lane	5120 x 2160 @ 60 Hz
5.4G 4-Lane DSC	5120 x 2160 @ 120 Hz
5.4G 4-Lane	5120 x 2160 @ 60 Hz



Pin assignments

DP port (in)

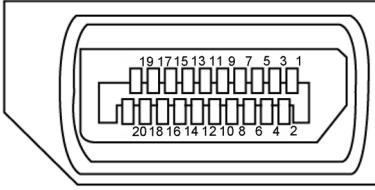

Pin number	20-pin side of the connected signal cable
1	ML3(n)
2	GND
3	ML3(p)
4	ML2(n)
5	GND
6	ML2(p)
7	ML1(n)
8	GND
9	ML1(p)
10	ML0(n)
11	GND
12	ML0(p)
13	CONFIG1
14	CONFIG2
15	AUX CH (p)
16	GND
17	AUX CH (n)
18	Hot Plug Detect
19	Return
20	DP_PWR



HDMI port

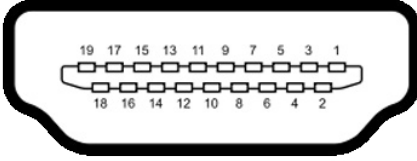

Pin number	19-pin side of the connected signal cable
1	TMDS DATA 2+
2	TMDS DATA 2 SHIELD
3	TMDS DATA 2-
4	TMDS DATA 1+
5	TMDS DATA 1 SHIELD
6	TMDS DATA 1-
7	TMDS DATA 0+
8	TMDS DATA 0 SHIELD
9	TMDS DATA 0-
10	TMDS CLOCK+
11	TMDS CLOCK SHIELD
12	TMDS CLOCK-
13	CEC
14	Reserved (N.C. on device)
15	DDC CLOCK (SCL)
16	DDC DATA (SDA)
17	DDC/CEC Ground
18	+5 V POWER
19	HOT PLUG DETECT



Thunderbolt™ 4/USB Type-C® port

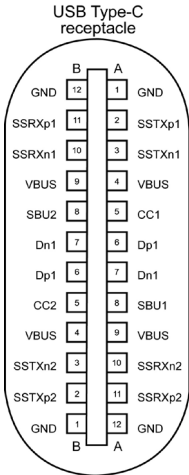



typically connected to a charger through a Type-C cable

Pin	Signal	Pin	Signal
A1	GND	B12	GND
A2	SSTXp1	B11	SSRXp1
A3	SSTXn1	B10	SSRXn1
A4	VBUS	B9	VBUS
A5	CC1	B8	SBU2
A6	Dp1	B7	Dn1
A7	Dn1	B6	Dp1
A8	SBU1	B5	CC2
A9	VBUS	B4	VBUS
A10	SSRXn2	B3	SSTXn2
A11	SSRXp2	B2	SSTXp2
A12	GND	B1	GND





Universal Serial Bus (USB)

This section gives you information about the USB ports available on your monitor.

 **NOTE:** Up to 5 V/1.5 A typical (2 A max) on USB-A downstream port (port with ) with BC 1.2 compliance devices; up to 0.9 A on the other five USB-A downstream ports; Up to 3 A on USB-C® downstream port (port with ) with 5 V/3 A compliance devices.

Your computer has the following USB ports:

- Two upstream - 1*TBT + 1*USB-C® at rear.
- Eight downstream - 2*USB-C® + 1*USB-A at bottom, 1*TBT + 4*USB-A at rear.

Power Charging Port - the ports with  battery icon supports fast current charging capability if the device is BC 1.2 compatible. The USB Type-C® downstream port with  icon supports fast current charging capability if the device is 5 V/3 A compatible.

 **NOTE:** The monitor's USB ports work only when the monitor is on or in Standby Mode. On in Standby Mode, if the USB cable (A to C or C to C) is plugged in, the USB ports can work normally. Otherwise, follow the OSD setting of Other USB Charging, if the setting is "On in Standby Mode" then USB work normally, otherwise USB is disabled. If you turn off the monitor and then turn it on, the attached peripherals may take a few seconds to resume normal functionality.

SuperSpeed USB 10 Gbps (USB 3.2 Gen2) device

Transfer speed	Data rate	Maximum power consumption (each port)
SuperSpeed+	10 Gbps	4.5 W
SuperSpeed	5 Gbps	4.5 W
High speed	480 Mbps	2.5 W
Full speed	12 Mbps	2.5 W



USB 3.2 Gen2 (10 Gbps)
downstream port (bottom)

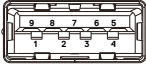

Pin number	Signal name
1	VBUS
2	D-
3	D+
4	GND
5	StdA_SSRX-
6	StdA_SSRX+
7	GND_DRAIN
8	StdA_SSTX-
9	StdA_SSTX+
Shell	Shield

USB 3.2 Gen2 (10 Gbps)
downstream port (rear)



Pin number	Signal name
1	VBUS
2	D-
3	D+
4	GND
5	StdA_SSRX-
6	StdA_SSRX+
7	GND_DRAIN
8	StdA_SSTX-
9	StdA_SSTX+
Shell	Shield



RJ45 port (connector side)

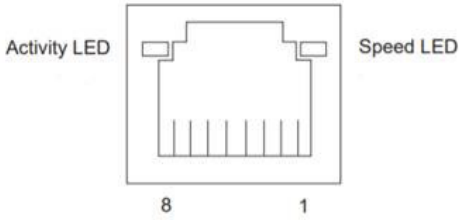

Pin No.	10BASE-T 100BASE-T	1000BASE-T
1	Transmit+	BI_DA+
2	Transmit-	BI_DA-
3	Receive+	BI_DB+
4	Unused	BI_DC+
5	Unused	BI_DC-
6	Receive-	BI_DB-
7	Unused	BI_DD+
8	Unused	BI_DD-

Driver installation

Install the Realtek USB GBE Ethernet Controller Driver available for your system. This is available for download at <https://www.dell.com/support> under the “Driver and download” section.

Network (RJ45) data rate through USB-C® max speed is 2.5 Gbps.



Wake-on-LAN behavior

Computer power save state	System behavior after receiving Wake-on-LAN (WOL) command
Modern Standby (S0ix)	The computer and Monitor remain in Standby mode but the network communication is enabled.
Standby/Sleep (S3)	Both computer and monitor are turned on.
Hibernate (S4)	Both computer and monitor are turned on.
OFF/Shutdown (S5)	Both computer and monitor are turned on.

 **NOTE: The computer BIOS must be configured to enable WOL function first.**

 **NOTE: This LAN port is 2.5GBase-T IEEE 802.3az compliant, supporting Mac Address (Printed on model label) Pass-thru (MAPT), Wake-on-LAN (WOL) from standby mode (S3) and UEFI* PXE Boot function [UEFI PXE Boot is not supported on Dell Desktop PC's (except for OptiPlex 7090/3090 Ultra Desktop)], these 3 features depend on BIOS settings and operating system versions. The functionality may vary with non-Dell PCs.**

*UEFI stands for Unified Extensible Firmware Interface.

 **NOTE: WOL S4 and WOL S5 are only capable with Dell Systems that support DPBS and are with Thunderbolt™/USB-C® (MFD) interface connection.**

 **NOTE: Any issue that is related to WOL, users should debug the computer without a monitor. After the problem is solved, then connect to the monitor.**



RJ45 Connector LED status:

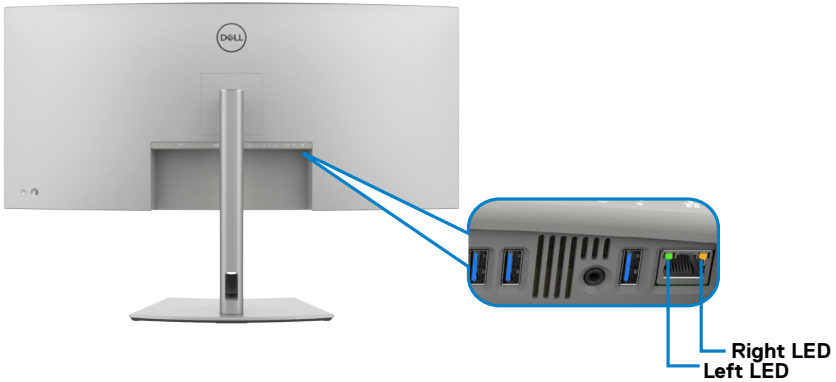

LED	Color	Description
Right LED	Amber or Green	Speed indicator: <ul style="list-style-type: none">• Amber On - 1000 Mbps/2.5 Gbps• Green On - 100 Mbps• Off - 10 Mbps
Left LED	Green	Link/Activity indicator: <ul style="list-style-type: none">• Blinking - Activity on the port.• Green On - Link is being established.• Off - Link is not established.

 **NOTE: RJ45 cable is not a standard in-box accessory.**



Plug-and-Play capability

You can connect the monitor to any Plug and Play-compatible system. The monitor automatically provides the computer with its Extended Display Identification Data (EDID) using Display Data Channel (DDC) protocols so that the computer can configure itself and optimize the monitor settings. Most monitor installations are automatic; you can select different settings as required. For more information about changing the monitor settings, see [Operating the Monitor](#).

LCD monitor quality and pixel policy

During the LCD Monitor manufacturing process, it is not uncommon for one or more pixels to become fixed in an unchanging state which are hard to see and do not affect the display quality or usability. For more information on Dell Monitor Quality and Pixel Policy, see <https://www.dell.com/pixelguidelines>.



Ergonomics

△ CAUTION: Improper or prolonged usage of keyboard may result in injury.

△ CAUTION: Viewing the monitor screen for extended periods of time may result in eye strain.

For comfort and efficiency, observe the following guidelines when setting up and using your computer workstation:

- Position your computer so that the monitor and keyboard are directly in front of you as you work. Special shelves are commercially available to help you correctly position your keyboard.
- To reduce the risk of eye strain and neck/arm/back/shoulder pain from using the monitor for long periods of time, we suggest you to:
 1. Set the distance of the screen between 20 in. to 28 in. (50 - 70 cm) from your eyes.
 2. Blink frequently to moisten your eyes or wet your eyes with water after prolonged usage of the monitor.
 3. Take regular and frequent breaks for 20 minutes every two hours.
 4. Look away from your monitor and gaze at a distant object at 20 ft away for at least 20 seconds during the breaks.
 5. Perform stretches to relieve tension in the neck, arm, back, and shoulders during the breaks.
- Make sure that the monitor screen is at eye level or slightly lower when you are sitting in front of the monitor.
- Adjust the tilt of the monitor, its contrast, and brightness settings.
- Adjust the ambient lighting around you (such as overhead lights, desk lamps, and the curtains or blinds on nearby windows) to minimize reflections and glare on the monitor screen.
- Use a chair that provides good lower-back support.
- Keep your forearms horizontal with your wrists in a neutral, comfortable position while using the keyboard or mouse.
- Always leave space to rest your hands while using the keyboard or mouse.
- Let your upper arms rest naturally on both sides.
- Ensure that your feet are resting flat on the floor.
- When sitting, make sure that the weight of your legs is on your feet and not on the front portion of your seat. Adjust your chair's height or use a footrest if necessary to maintain a proper posture.
- Vary your work activities. Try to organize your work so that you do not have to sit and work for extended periods of time. Try to stand or get up and walk around at regular intervals.



- Keep the area under your desk clear of obstructions and cables or power cords that may interfere with comfortable seating or present a potential trip hazard.

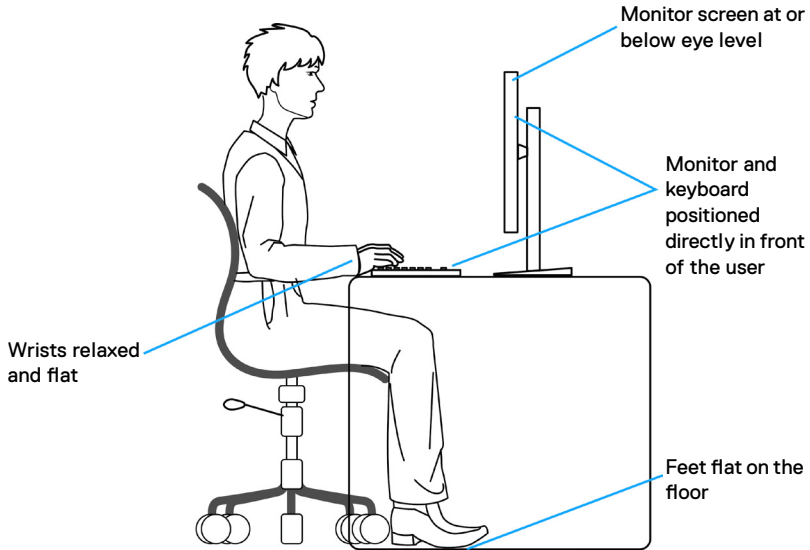

Handling and moving your display

To ensure the monitor is handled safely when lifting or moving it, follow the guidelines mentioned below:

- Before moving or lifting the monitor, turn off your computer and the monitor.
- Disconnect all cables from the monitor.
- Place the monitor in the original box with the original packing materials.
- Hold the bottom edge and the side of the monitor firmly without applying excessive pressure when lifting or moving the monitor.



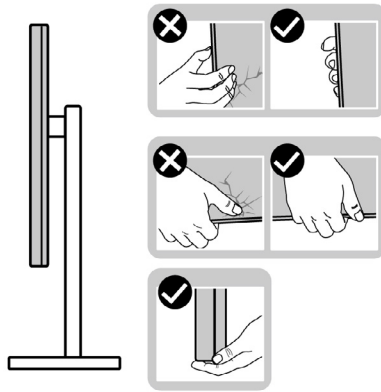

- When lifting or moving the monitor, ensure the screen is facing away from you and do not press on the display area to avoid any scratches or damage.

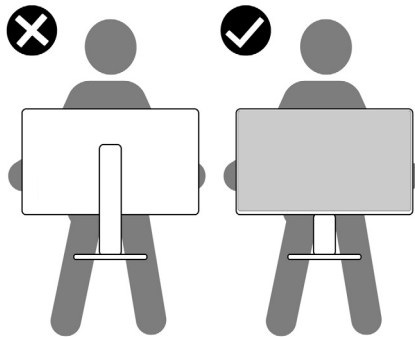

- When transporting the monitor, avoid any sudden shock or vibration to it.
- When lifting or moving the monitor, do not turn the monitor upside down while holding the stand base or stand riser. This may result in accidental damage to the monitor or cause personal injury.

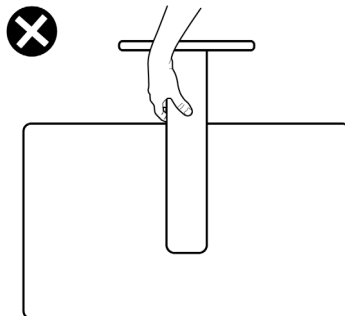

Maintenance guidelines

Cleaning your monitor

 **CAUTION:** Read and follow the [Safety instructions](#) before cleaning the monitor.

 **WARNING:** Before cleaning the monitor, unplug the monitor power cable from the electrical outlet.

For best practices, follow the instructions in the list below when unpacking, cleaning, or handling your monitor:

- Use a clean cloth that is slightly dampened with water to clean the stand assembly, the screen, and the chassis of your Dell monitor. If available, use a screen-cleaning tissue or solution suitable for cleaning Dell monitors.
- After cleaning the surface of the table, ensure that it is thoroughly dry and free from any moisture or cleaning agent before placing your Dell monitor on it.

 **CAUTION:** Do not use detergents or other chemicals such as benzene, thinner, ammonia, abrasive cleaners, alcohol, or compressed air.

 **CAUTION:** Using chemicals for cleaning may cause changes in the appearance of the monitor, such as color fading, milky film on the monitor, deformation, uneven dark shade, and peeling of screen area.

 **WARNING:** Do not spray the cleaning solution or even water directly on the surface of the monitor. Doing so allows liquids to accumulate at the bottom of the display panel and corrode the electronics resulting in permanent damage. Instead, apply the cleaning solution or water to a soft cloth and then clean the monitor.



 **NOTE:** Monitor damages due to improper cleaning methods and the use of benzene, thinner, ammonia, abrasive cleaners, alcohol, compressed air, detergent of any kind will lead to a Customer Induced Damage (CID). CID is not covered under the standard Dell warranty.

- If you notice white residual powder when you unpack your monitor, wipe it off with a cloth.
- Handle your monitor with care as a darker-colored monitor may get scratched and show white scuff marks more than a lighter-colored monitor.
- To help maintain the best image quality on your monitor, use a dynamically changing screen saver and turn off your monitor when not in use.



Setting up the monitor

Attaching the stand

-  **NOTE:** The stand is not installed at the factory when shipped.
-  **NOTE:** The following instructions are applicable only for the stand that was shipped with your monitor. If you are attaching a stand that you purchased from any other source, follow the setup instructions that were included with the stand.

To attach the monitor stand:

1. Align and place the stand riser on the stand base.
2. Open the screw handle at the bottom of the stand base and turn it clockwise to secure the stand assembly.
3. Close the screw handle.

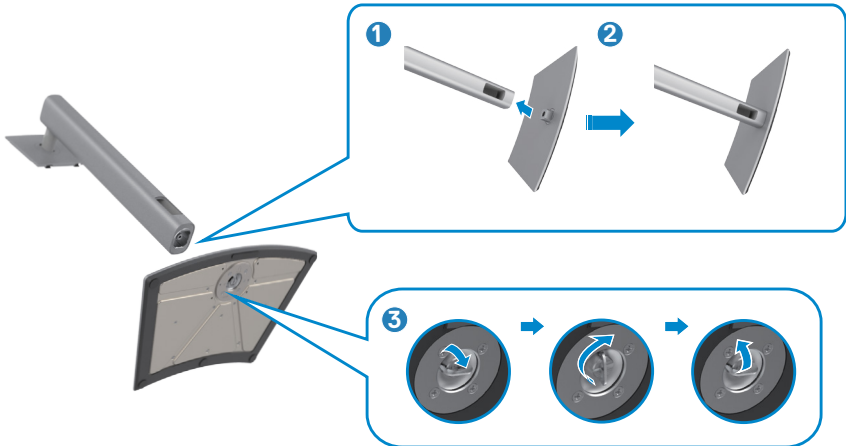

4. Open the protective cover on the monitor to access the VESA slot on the monitor.

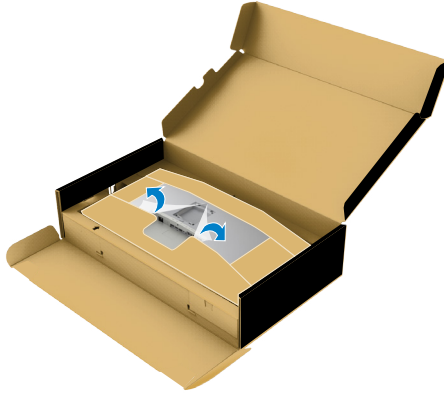

5. Slide the tabs on the stand riser into the slots on the display back cover and lower the stand assembly to snap it into place.

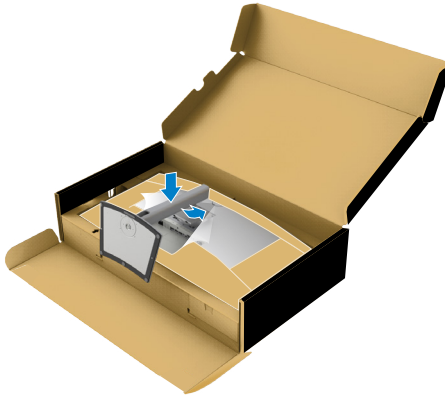

6. Hold the stand riser and lift the monitor carefully, then place it on a flat surface.



NOTE: Hold the stand riser firmly when lifting the monitor to avoid any accidental damage.

7. Tear the paper cushion from the monitor.

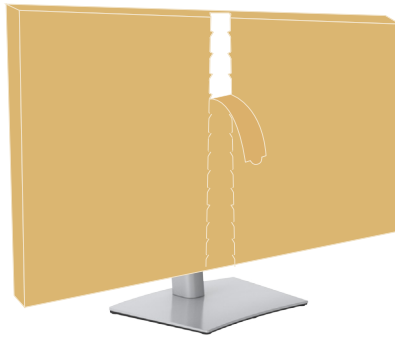

Using the tilt, swivel, and vertical extension

NOTE: The following instructions are applicable only for the stand that was shipped with your monitor. If you are connecting a stand that you purchased from any other source, follow the setup instructions that were included with the stand.

Tilt, swivel, and vertical extension

With the stand that is attached to the monitor, you can tilt the monitor for the most comfortable viewing angle.

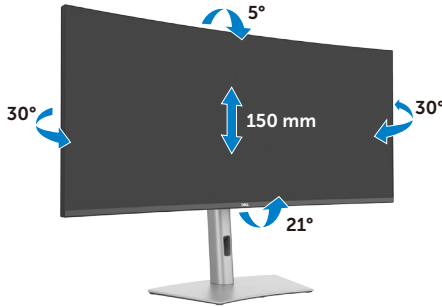

NOTE: The stand is detached when the monitor is shipped from the factory.

Organizing your cables



After attaching all necessary cables to your monitor and computer, (see [Connecting Your Monitor](#) for cable attachment) organize all cables as shown above.

If your cable is not able to reach your PC, you may connect directly to the PC without routing through the slot on the monitor stand.



Connecting your monitor

⚠ WARNING: Before you begin any of the procedures in this section, follow the [Safety Instructions](#).

🔧 NOTE: Dell monitors are designed to work optimally with the Dell supplied cables inside the box. Dell does not guarantee the video quality and performance if non-Dell cables are used.

🔧 NOTE: Route the cables through the cable-management slot before connecting them.

🔧 NOTE: Do not connect all the cables to the computer simultaneously.

🔧 NOTE: The images are for the purpose of illustration only. The appearance of the computer may vary.

To connect your monitor to the computer:

1. Turn off your computer.
2. Connect the DisplayPort or USB cable, and the Thunderbolt™ 4 cable from your monitor to the computer.

⚠ CAUTION: Before using the monitor, it is recommended to fasten the stand riser to a wall using cable tie or a cord that can support the weight of monitor in order to prevent the monitor from falling.

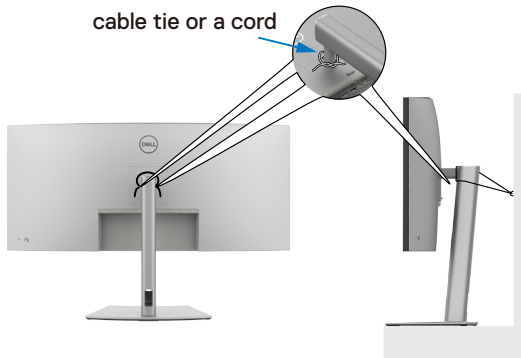

3. Turn on your monitor.
4. Select the correct input source from the OSD Menu on your monitor and then turn on your computer.

🔧 NOTE: U4025QW default setting is DisplayPort 1.4. A DisplayPort 1.4 Graphic card may not display normally. See [product specific problems – No image when using DP connection to the PC](#) to change the default setting.

🔧 NOTE: Remove the rubber plug when using Thunderbolt™ 4 downstream or USB-C® upstream connector.



Connecting the HDMI cable



Switch to lower or higher primary resolution

1. Press the joystick button to launch the OSD main menu.
2. Move the joystick to select **input source**.

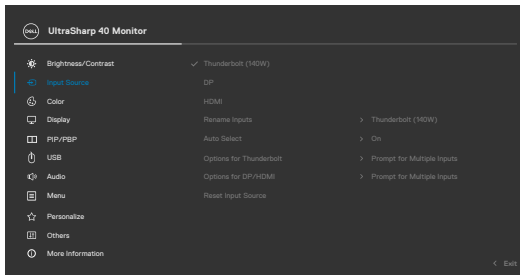

3. Move the joystick up or down to select **HDMI**, press and hold the joystick 8 seconds, the following message will appear:

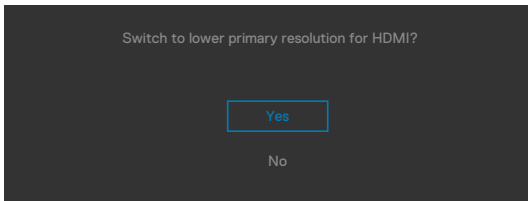

4. Select **Yes** to switch from HDMI 2.1 EDID and max resolution is 5K to HDMI 1.4 and max resolution is 4K (or select No to cancel this operation).
5. Repeat steps 3 and 4 again to switch from HDMI 1.4 and max resolution is 4K to HDMI 2.1 EDID and max resolution is 5K.

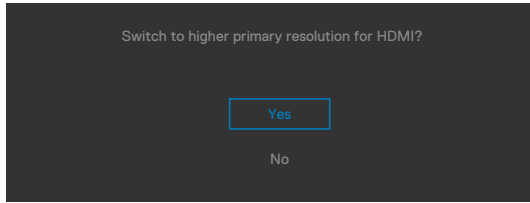

Connecting the DP cable



Connecting the Thunderbolt™ 4 cable

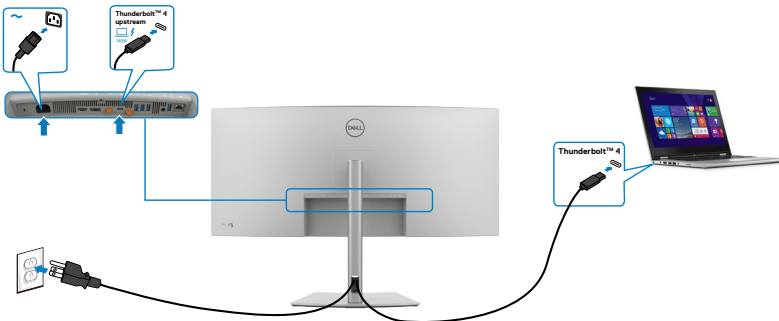

Connecting the USB-C® Cable (A to C)

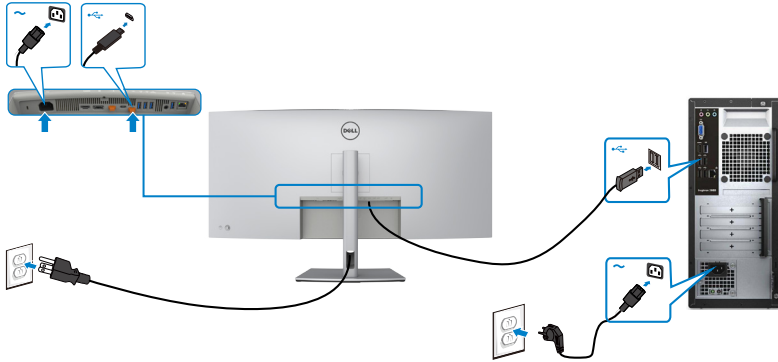

Connecting the USB Type-C® cable (C to C) (Optional)



NOTE: This connection only data is available and no video. Need another video connection for display.

NOTE: Regardless of the power requirement/actual power consumption of your laptop, or the remaining power runtime in your battery, the Dell monitor is designed to supply power delivery of up to 140 W to your laptop.

Rated power (on laptops that have USB Type-C® with Power Delivery)	Maximum charging power
45 W	45 W
90 W	90 W
140 W	*140 W

*Need laptops to support EPR 140 W charging.

WARNING: The Dell UltraSharp U4025QW supports the USB Type-C® Power Delivery 3.1 (Thunderbolt™ 4) specification and can provide a



maximum output of up to 140 W. For safety consideration, this USB Type-C® port must be connected to the Dell-approved products with the inbox Thunderbolt™ 4 Active cable. For the list of Dell-approved products, refer Dell products compatible with USB Type-C® Power Delivery 3.1 (Extended Power Range 140W) Tech sheet at Dell.com/support/U4025QW.

Connecting the monitor for Thunderbolt™ 4 daisy chain function

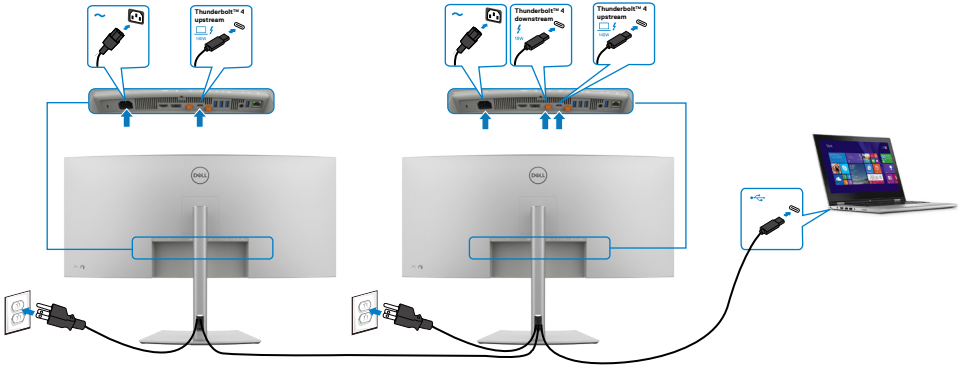

- NOTE:** Only support two monitors through Thunderbolt™ 4 daisy chain. See [product specific problems –No image when using Thunderbolt™ 4 daisy chain](#).
- NOTE:** Use the OSD menu to set Thunderbolt Daisy Chain option to Optimized. So that both monitors can display 5120 x 2160 120Hz mode.

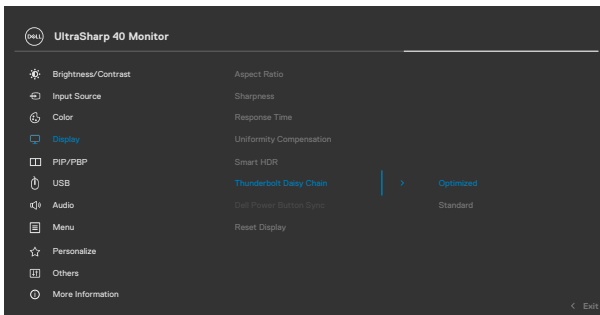

Connecting the monitor for RJ45 Cable (Optional)

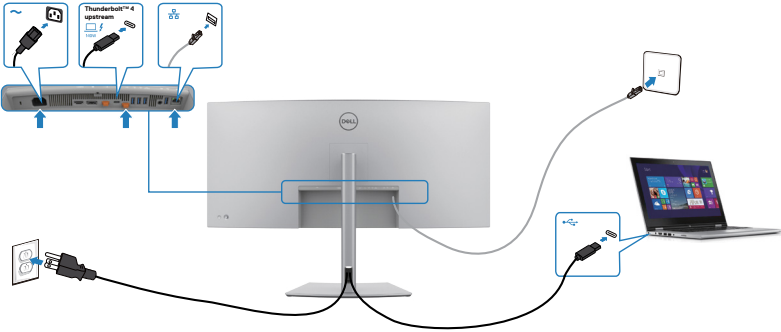

Dell Power Button Sync (DPBS)

Your monitor is designed with a Dell Power Button Sync (DPBS) feature to allow you to control PC system power state from the monitor power button. This feature is only supported with the Dell platform which has a built-in DPBS function, and is only supported over Thunderbolt™ 4 interface.



To make sure the DPBS function works for the first time, perform the following steps on the DPBS supported platform in the **Control Panel** first.

NOTE: DPBS only supports the Thunderbolt™ 4 port.

1. Go to the **Control Panel**.

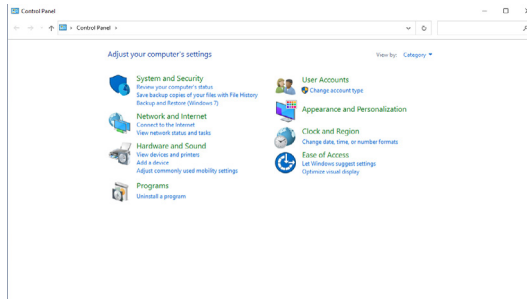

2. Select **Hardware and Sound**, followed by **Power Options**.

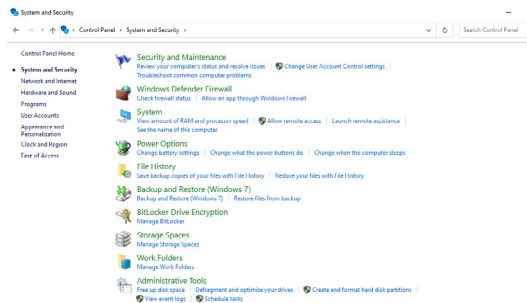

3. Go to the **System Settings**.

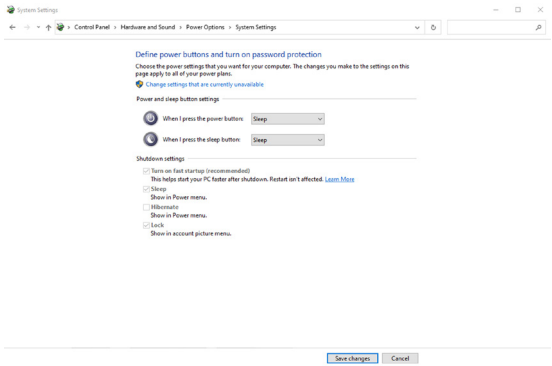

4. In the **When I press the power button** drop-down list, you can select Sleep, Hibernate, or Shut down.

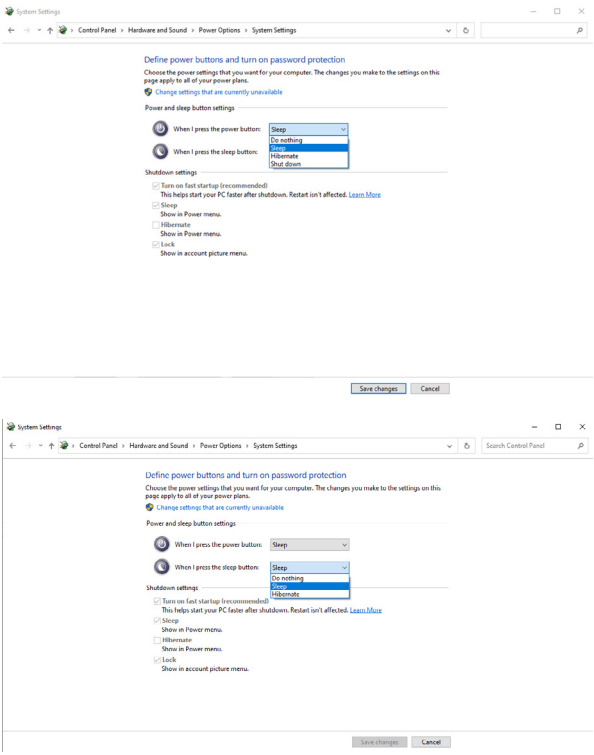

NOTE: Do not select Do nothing, otherwise monitor power button cannot sync with PC system power state.



5. Go to Monitor OSD Display, turn **On** from off in Dell Power Button Sync.

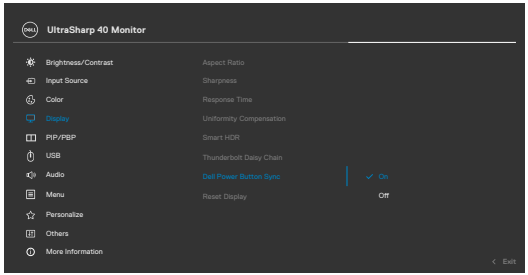

Connecting the monitor for DPBS for the first time

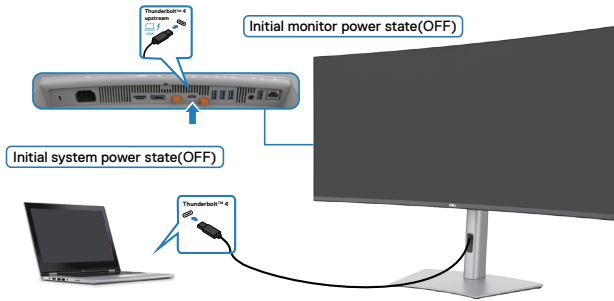

For the first time DPBS function setup, follow the below steps:

1. Ensure both the PC and monitor are off.
2. Connect the Thunderbolt™ 4 cable from the PC to the monitor.
3. Press the monitor power button to turn ON the monitor.
4. Both the monitor and PC turn normally. If not, press either the monitor power button or PC power button to boot the system.
5. When you connect the Dell OptiPlex 7090/3090 Ultra platform, you may see both the monitor and the PC turn on momentarily. Wait for a while (approximately 6 seconds) and both the PC and monitor will turn OFF. When you press either the monitor power button or PC power button, both the PC and monitor turn on. The PC system power state is synchronized with the monitor power button.

NOTE: When the monitor and PC are both at power OFF state at first time, it is recommended that you turn ON the monitor first, then connect the Thunderbolt™ 4 cable from the PC to the monitor.

NOTE: You can power the Dell PC* Ultra platform using its DC adapter jack. Alternatively, you can power the Dell PC* Ultra platform using the monitor's Thunderbolt™ 4 cable over Power Delivery (PD); Set Thunderbolt™ 4 charging to on from off mode.

* Ensure to check the Dell PC for DPBS supportability.



Using DPBS function

When you press the monitor power button or PC power button, the Monitor/PC state is as follows:

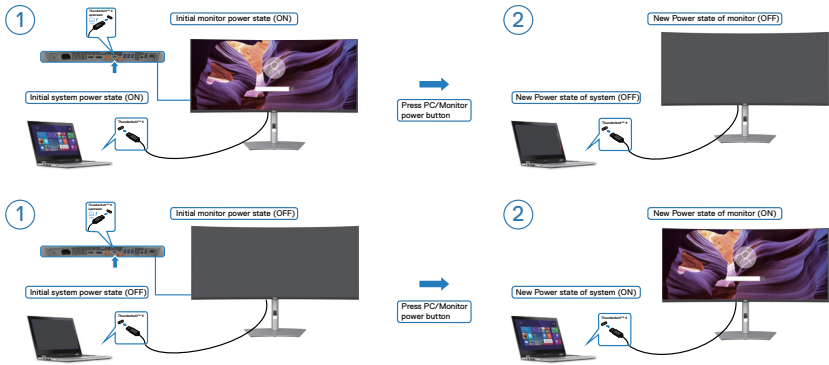

When the monitor and PC power state are both ON, while you **press and hold the power button for 4 seconds**, the screen prompts if you would like to shut down the PC.

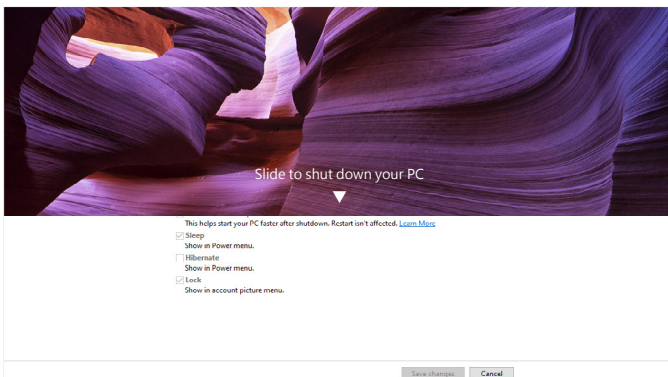
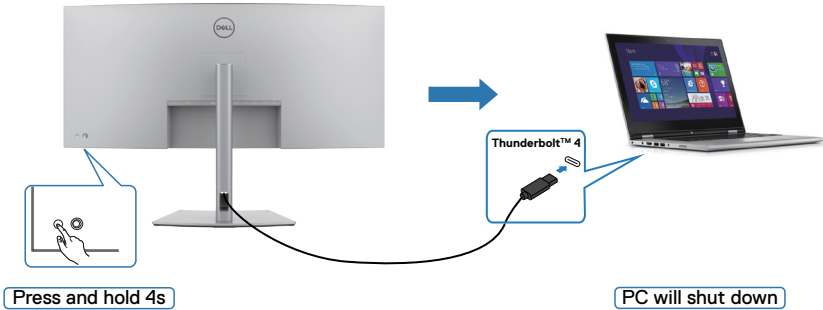

When the monitor and PC power state are both ON, while **you press and hold the monitor power button for 10 seconds**, the PC shuts down.

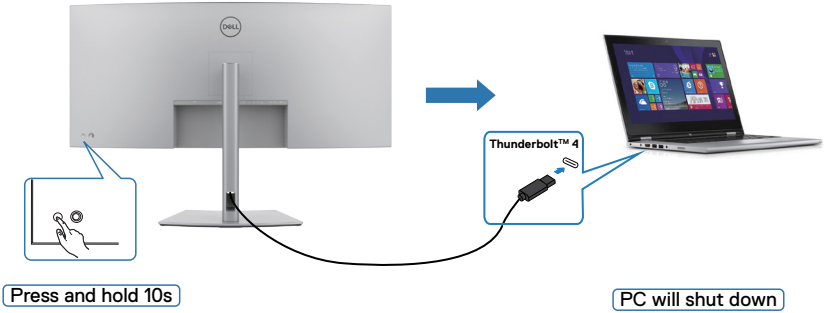

Connecting the monitor for Thunderbolt™ daisy chain function

A PC is connected to two monitors in an initially off power state, and the PC power state is synchronized with the Monitor 1 power button. When you press the Monitor 1 or PC power button, both the Monitor 1 and PC turn on. Meanwhile the Monitor 2 will remain off. You need to manually press the power button on Monitor 2 to turn it on.

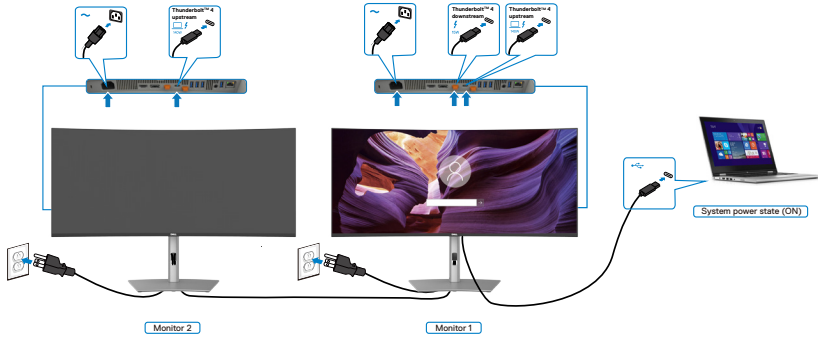

Similarly, a PC is connected to two monitors in an initially on power state, and the PC system power state is synchronized with the Monitor 1 power button. When you press the Monitor 1 or PC power button, both the Monitor 1 and PC turn off. Meanwhile the Monitor 2 will be in Standby mode. You need to manually press the power button on Monitor 2 to turn it off.

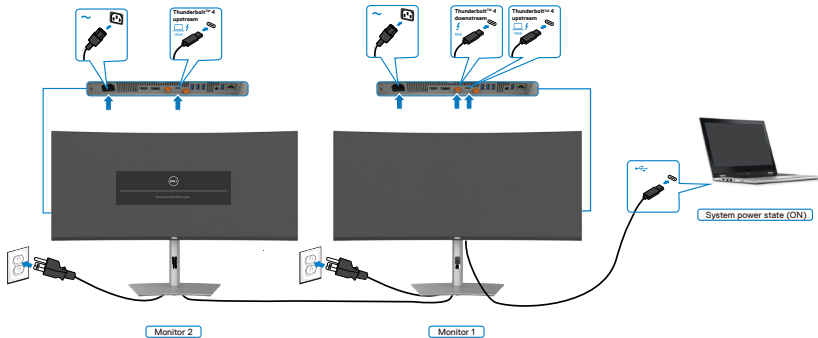

Connect multiple Thunderbolt™ 4 monitors to one system

The Dell PC* Ultra platform has two Thunderbolt™ 4 ports, so both Monitor 1 and Monitor 2 power states can synchronize with the PC.

While the PC and two monitors are in an initially ON power state, by pressing the power button on Monitor 1 or Monitor 2 will turn OFF the PC, Monitor 1, and Monitor 2.

* Ensure to check the Dell PC for DPBS supportability.

NOTE: DPBS only supports the Thunderbolt™ 4 port.

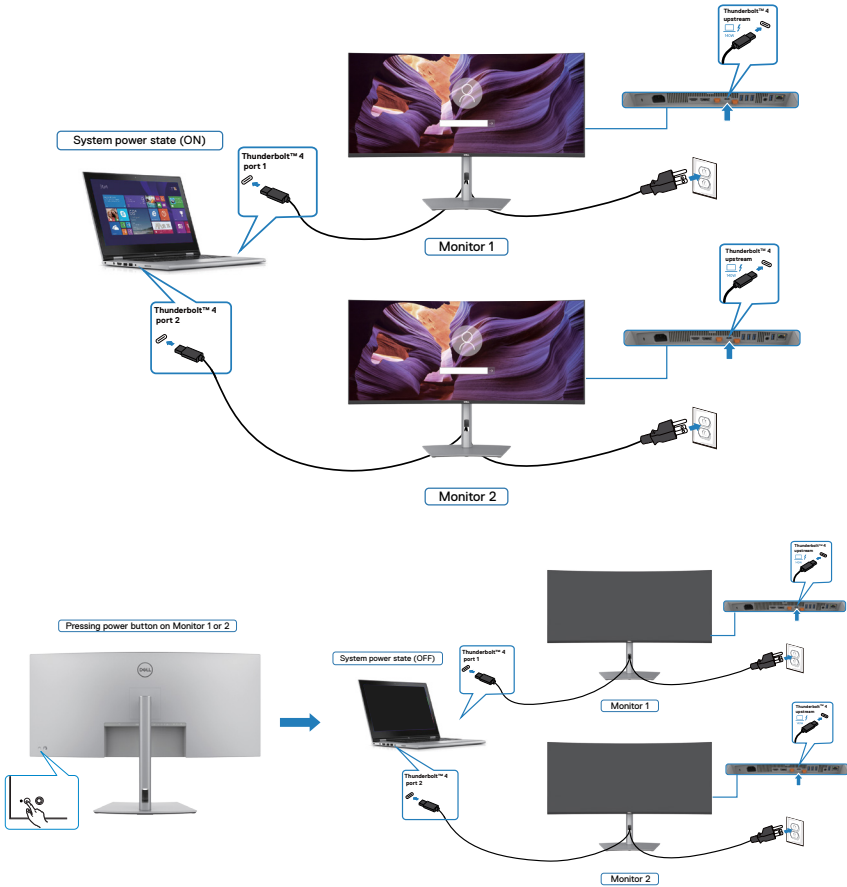

Make sure to set **Thunderbolt™ 4** to On in Off Mode. While the PC and two monitors are in an initially OFF power state, by pressing the power button on Monitor 1 or Monitor 2 will turn ON the PC, Monitor 1, and Monitor 2.

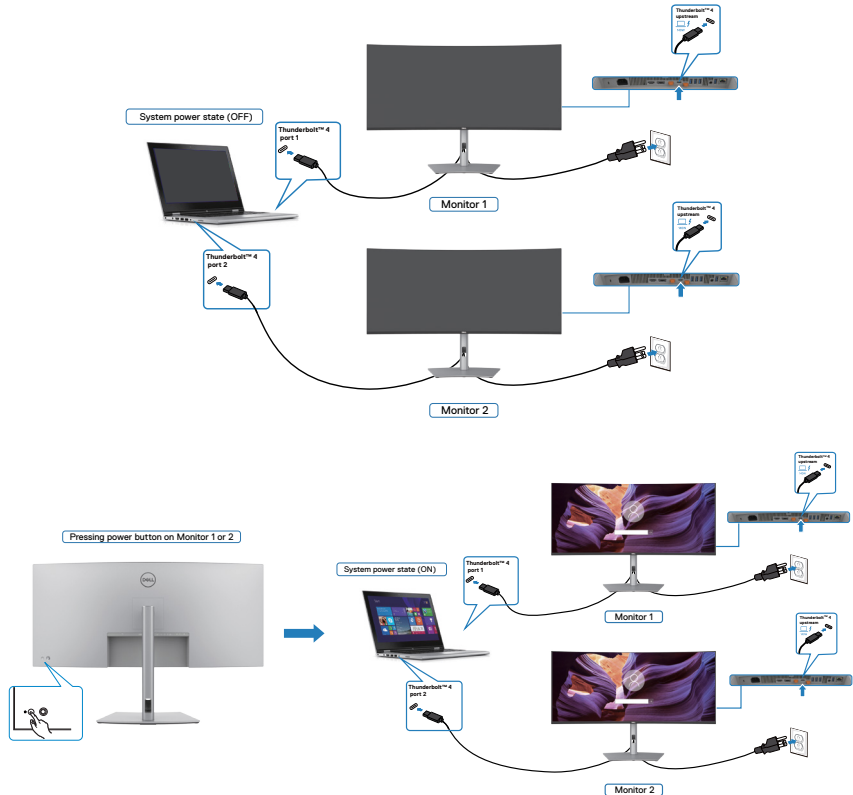

Securing your monitor using Kensington lock (optional)

The security lock slot is located at the bottom of the monitor (see [Security lock slot](#)). Secure your monitor to a table using the Kensington security lock.

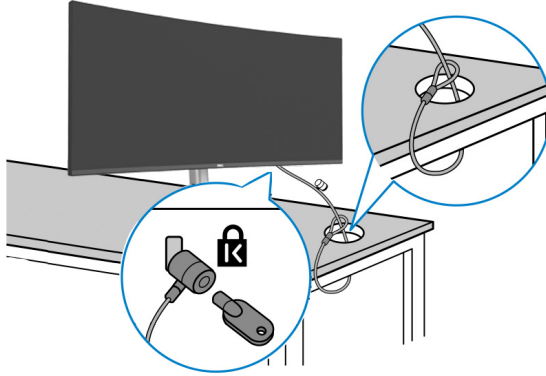

For more information on using the Kensington lock (purchased separately), see the documentation that is shipped with the lock.



NOTE: The image is for the purpose of illustration only. The appearance of the lock may vary.



Removing the monitor stand

-  **NOTE:** To prevent scratches on the LCD screen when removing the stand, ensure that the monitor is placed on a soft surface and handle it carefully.
-  **NOTE:** The following steps are specific for removing the stand that is shipped with your monitor. If you are removing a stand that you purchased from any other source, follow the setup instructions that are included with the stand.

To remove the stand:

 **CAUTION:** Place the monitor screen on the desktop. Take note that the webcam is slightly protruded out of the monitor screen, please protect the webcam surface to prevent wear by the desktop.

1. Place the monitor on a soft cloth or cushion.
2. Press and hold the stand-release button.
3. Lift the stand up and away from the monitor.

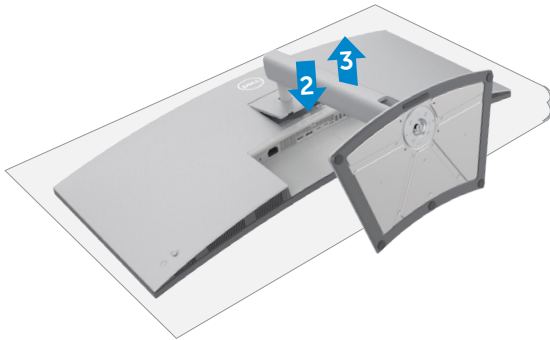

Wall mounting (Optional)

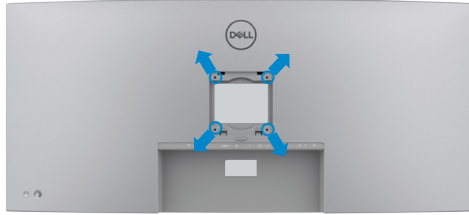

NOTE: Use M4 x 10 mm screws to connect the monitor to the wall-mounting kit.

See the instructions that come with the VESA-compatible wall mounting kit.

1. Place the monitor on a soft cloth or cushion on a stable flat table.
2. Remove the stand.
3. Use a Phillips crosshead screwdriver to remove the four screws securing the plastic cover.
4. Attach the mounting bracket from the wall mounting kit to the monitor.
5. Mount the monitor on the wall as instructed in the documentation that shipped with the wall-mounting kit.

NOTE: For use only with UL or CSA or GS-listed wall mount bracket with minimum weight/load bearing capacity of 33.40 kg (73.63 lb).



Operating the monitor

Power on the monitor

Press the  button to turn on the monitor.

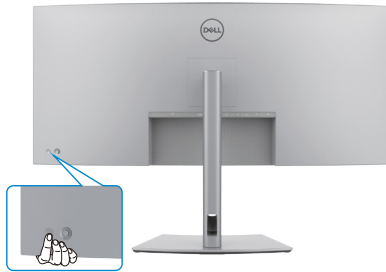

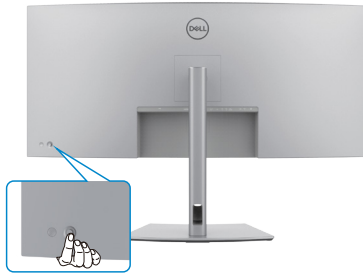

Using the joystick control



To modify the OSD adjustments using the joystick control on the rear end of the monitor, do the following:

1. Press the joystick to open the OSD Menu Launcher.
2. Move the joystick up/down/left/right to switch between the OSD menu options.

Joystick Functions

Joystick	Description
	Press the joystick to open the OSD Menu Launcher.
	For right and left navigation.
	For up and down navigation.



Enable Menu Voice function

This is an accessibility feature for people who are visually impaired.

This feature can also be disabled in the Main Menu.

1. Power on the monitor by pressing the power button.
2. Connect the **Dell Monitor Text to Speech User Interface Module-TS23*** to the USB port marked **CVAA** at the back of the monitor. Upon successful connection to the correct USB port, you will receive an audio feedback saying **CVAA connected**.
3. Utilize the joystick to activate the On-Screen Display (OSD) menu.

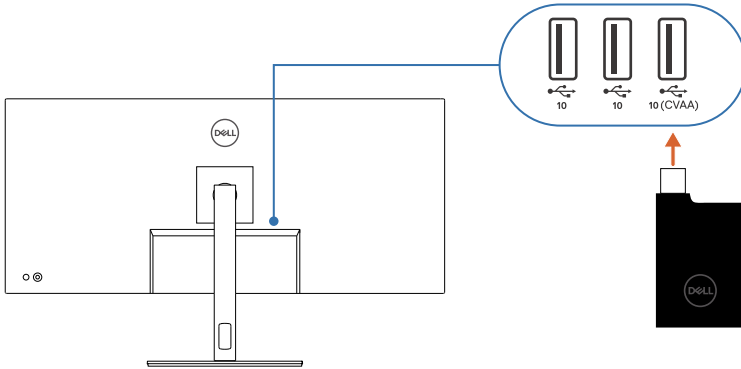

NOTE: After setting up, you may press and hold the Joystick for 3 seconds to deactivate or reactivate the Menu Voice.

NOTE: The following functions are disabled when Menu Voice is on:

- Menu Lock
- Language
- PIP/PBP

For additional information, go to:

<https://www.dell.com/learn/us/en/uscorp1/policies-website-accessibility>.

*Compliant with the 21st Century Communications and Video Accessibility Act (CVAA).



Using the rear-panel controls

Press the Joystick to open the OSD Menu Launcher.







Menu Launcher

- Toggle the Joystick **Up** to open the **Main Menu**.
- Toggle the Joystick **Left** or **Right** to select the preferred **Shortcut keys**.
- Toggle the Joystick **Down** to **Exit**.

Menu Launcher details

The following table describes the Menu Launcher icons:

Options	Description
 Menu	Use this Menu button to launch the on-screen display (OSD) and select the OSD menu.
 Shortcut key: Display Info	Use this button to choose from a list of Display Info .
 Shortcut key: Input Source	Use this button to choose from a list of Input Source .
 Shortcut key: Preset Modes	Allows to choose from a list of Preset color modes .
 Shortcut key: Brightness/Contrast	To directly access the Brightness/Contrast adjustment sliders.



Options



**Shortcut key:
Auto Brightness**

Description

Use this button to enable the Ambient Light Sensor to auto-adjust the luminance setting.



Exit

Use this button to go back to the main menu or **exit** the OSD main menu.



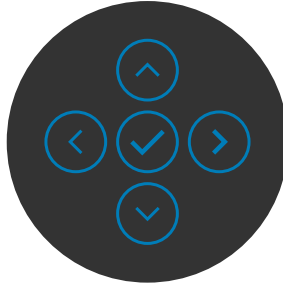

Front-panel button

Use the buttons on the front of the monitor to adjust the image settings.





Front Panel

Description

- | | | |
|---|---|--|
| 1 |   | Use the Up (increase) and Down (decrease) buttons to adjust items in the OSD menu. |
| | Up Down | |
| 2 |  | Use the Previous button to go back to the previous menu. |
| | Previous | |
| 3 |  | Use the Next button to confirm your selection. |
| | Next | |
| 4 |  | Use the Tick button to confirm your selection. |
| | Tick | |

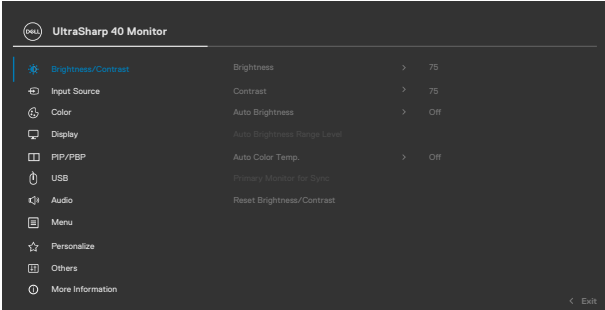

Using the Main Menu

Icon	Menu and Submenus	Description
	Brightness/Contrast	Adjust the Brightness, Contrast, Auto Brightness, Auto Brightness Range Level, Auto Color Temp., and Primary Monitor for Sync functions.
		
		
	Brightness	Adjusts the luminance of the backlight (Range: 0-100). Move the Joystick Up to increase brightness. Move the Joystick Down to decrease brightness.
	Contrast	Adjust the Brightness first, and then adjust Contrast only if further adjustment is necessary. Move the Joystick Up to increase contrast and Move the Joystick Down to decrease contrast (Range: 0-100). The Contrast function adjusts the degree of difference between darkness and lightness on the monitor screen.
	Auto Brightness	Enabled Ambient Light Sensor to auto-adjust the luminance setting.
	Auto Brightness Range Level	It is used for selecting the upper luminance threshold of Auto Brightness function. NOTE: When Auto Brightness is turned off, this function is not available.







Icon	Menu and Submenus	Description
	Auto Color Temp.	Enabled Ambient Light Sensor to auto-adjust the monitor color temperature to match to the ambient light.
	Primary Monitor for Sync	When either Auto Brightness or Auto Color Temp. is turned on and multiple Dell monitors that support this function are connected through daisy chain , one of the monitors can be appointed as the Primary to synchronize the Brightness and Color setting with the other. NOTE: When Auto Brightness and Auto Color Temp. are both turned off, this function is not available. NOTE: If the primary or secondary monitor breaks off from the daisy chain , it also breaks off from the monitor sync. NOTE: Use DDM software to enable this feature when daisy-chaining monitor with a Thunderbolt™ port.
	Reset Brightness/Contrast	Press the joystick to reset all settings under the Brightness/Contrast menu to the factory preset values.

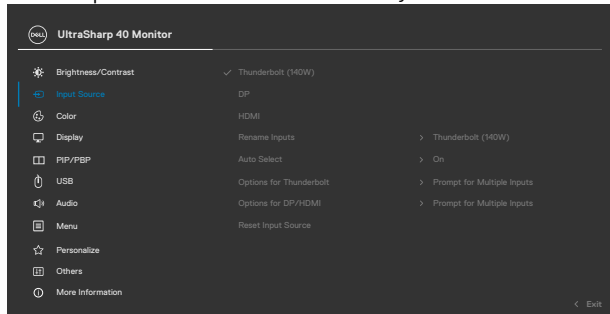

Input Source

Use the **Input Source** menu to select between different video inputs that are connected to your monitor.



Icon	Menu and Submenus	Description
	Thunderbolt (140W)	Select Thunderbolt (140W) input when you are using the Thunderbolt (140W) connector. Press the joystick button to confirm the selection.
	DP	Select DP input when you are using the DP (DisplayPort) connector. Press the joystick button to confirm the selection.
	HDMI	Select the HDMI input when you are using the HDMI connector. Press the joystick button to confirm the selection.
	Rename Inputs	Allows you to Rename Inputs .
	Auto Select	Allows you to scan for available input sources. Press  to select this function.
	Options for Thunderbolt	Press  to select these functions: <ul style="list-style-type: none"> • Prompt for Multiple Inputs: Always show Switch to Thunderbolt Video Input message for user to choose whether to switch or not. • Always Switch: The monitor always switches to Thunderbolt video by default while Thunderbolt is connected. • Off: The monitor does not auto-switch to Thunderbolt video from another available input.
	Options for DP/HDMI	Press  to select these functions: <ul style="list-style-type: none"> • Prompt for Multiple Inputs: Always show Switch to DP/HDMI Video Input message for user to choose whether to switch or not. • Always Switch: The monitor always switches to DP/HDMI video by default while DP/HDMI is connected. • Off: The monitor does not auto-switch to DP/HDMI video from another available input.
	Reset Input Source	Resets all settings under the Input Source menu to the factory defaults. Press  to select this function.



Icon	Menu and Submenus	Description
	Color	Adjusts the color setting mode.

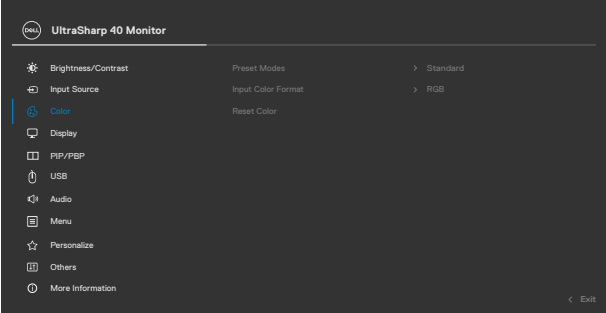

Preset Modes When you select **Preset Modes**, you can choose **Standard, Movie, Game, Color Temp, Color Space, or Custom Color** from the list.

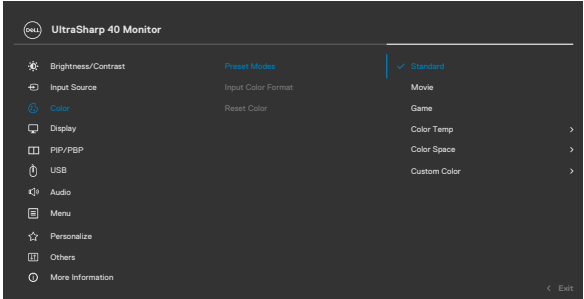

Icon	Menu and Submenus	Description
		<ul style="list-style-type: none"> ♦ Standard: Default Color setting. This monitor is certified with TÜV HW LBL at Standard color preset mode. ♦ Movie: Ideal for movies. ♦ Game: Ideal for most gaming applications. ♦ Color Temp: The screen appears warmer with a red/yellow tint with a slider set at 5,000 K or cooler with a blue tint with slider set at 10,000 K. ♦ Color Space: Allows users to select the color space: sRGB, BT.709, DCI-P3, Display P3. ♦ Custom Color: Allows you to manually adjust the color settings. Press the joystick left and right buttons to adjust the Red, Green, and Blue values and create your own preset color mode.

Input Color Format

Allow you to change the video color mode manually if the video content does not support auto selection.

- ♦ **RGB:** Select this option if your monitor is connected to a computer or a media player that supports RGB output.
- ♦ **YCbCr:** Select this option if your media player supports only YCbCr output.

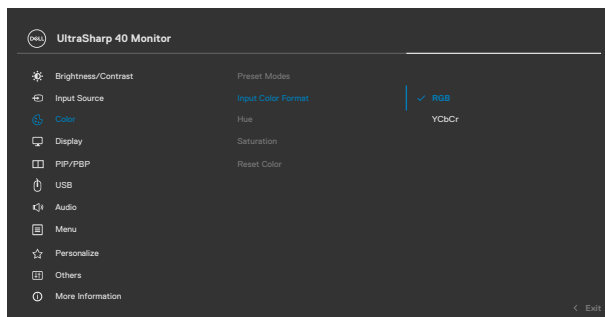

Hue

Use Joystick **Up** or **Down** to adjust the **Hue** from '0' to '100'.

NOTE: Hue adjustment is available only for **Movie** and **Game** mode.



Icon	Menu and Submenus	Description
	Saturation	Use Joystick Up or Down to adjust the Saturation from '0' to '100'. NOTE: Saturation adjustment is available only for Movie and Game mode.
	Reset Color	Resets your monitor's color settings to the factory defaults. Press  to select this function.



Display

Use the **Display** menu to adjust image.

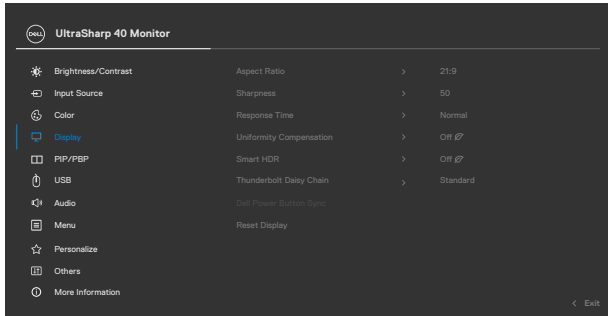

Aspect Ratio	Adjust the image ratio to 21:9 , Auto Resize , 4:3 , 1:1 .
Sharpness	Makes the image look sharper or softer. Move the joystick up and down to adjust the sharpness from '0' to '100'.
Response Time	Allows you to set the Response Time to Normal or Fast .



Icon	Menu and Submenus	Description
	Uniformity Compensation	<p>Select screen uniformity compensation settings. Uniformity Compensation adjusts different areas of the screen with respect to the center to achieve uniform brightness and color over the entire screen. For optimal screen performance, Brightness and Contrast for some preset modes (Standard, Color Temp.) will be disabled when Uniformity Compensation is turned On.</p> <p>NOTE: The user is advised to use factory default brightness setting when Uniformity Compensation is turned on. For other brightness level settings, the uniformity performance may deviate from the data that are shown on the Factory Calibration Report.</p> <p>NOTE: Auto Brightness and Auto Color Temp are disabled when Uniformity Compensation is turned On.</p> <p>NOTE: Uniformity Compensation is disabled when HDR display content is activated.</p>

Smart HDR

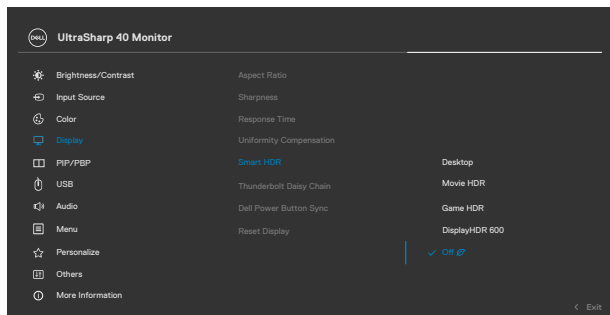

Press  to select these functions.

Smart HDR (High Dynamic Range) automatically enhances the display output by adjusting the settings optimally to resemble life-like visuals.

Desktop: This is the default mode. This mode is more suitable for general usage of the monitor with a desktop computer.



Icon	Menu and Submenus	Description
		<p>Movie HDR: Use this mode during playback of HDR video content to expand the contrast ratio, brightness, and color palette. It matches the video quality with real life visuals.</p> <p>Game HDR: Use this mode when playing games that support HDR to expand the contrast ratio, brightness, and color palette. It makes the gaming experience more realistic as intended by game developers.</p> <p>DisplayHDR: Best used with content that complies with DisplayHDR standards.</p> <p>Off: Disables Smart HDR function.</p> <p>NOTE: The possible peak luminance during HDR mode is 600-nits (typical). The actual value and duration during HDR playback might vary accordingly to the video content.</p> <p>NOTE: HDR option on both the Monitor and Computer must be enabled to activate HDR display content. Auto Brightness and Auto Color Temp. are disabled when Smart HDR is enabled.</p>
	Thunderbolt Daisy Chain	<p>Bandwidth management for operating of two daisy chained monitors up to the maximum resolution of 5120 x 2160 120Hz.</p> <p>Select Optimized for dual 5120 x 2160 120Hz display. Select Standard when not in daisy chaining the Monitor or prefer to have dual 5120 x 2160 60Hz display.</p> <p>NOTE: The display resolution and refresh rate are also dependent on the computer's graphic card capability.</p>
	Dell Power Button Sync	<p>To allow you to control PC system power state from the monitor power button.</p> <p>Allows you to On or Off Dell Power Button Sync function.</p> <p>NOTE: This feature is only supported with the Dell platform which has a built-in DPBS function, and is only supported over Thunderbolt interface.</p>
	Reset Display	<p>Resets all settings under the Display menu to the factory defaults.</p> <p>Press  to select this function.</p>



Icon	Menu and Submenus	Description
------	-------------------	-------------



PIP/PBP

This function brings up a window displaying an image from another input source.

NOTE: The PBP/PIP, Screen Partition do not support HDR, and VRR/DRR.

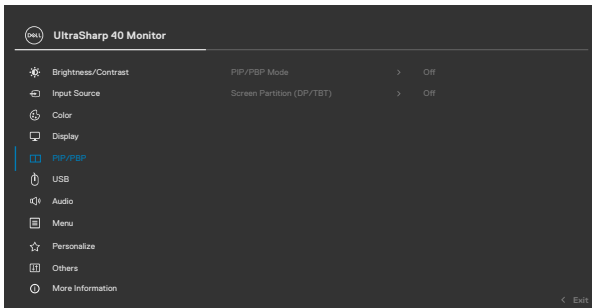

Main Window	Sub-Window		
	Thunderbolt (140W)	DP	HDMI
Thunderbolt (140W)		✓	✓
DP	✓		✓
HDMI	✓	✓	



Icon	Menu and Submenus	Description
------	-------------------	-------------

PIP/PBP Mode Adjusts the PIP or PBP (Picture by Picture) mode. You can disable this feature by selecting Off.

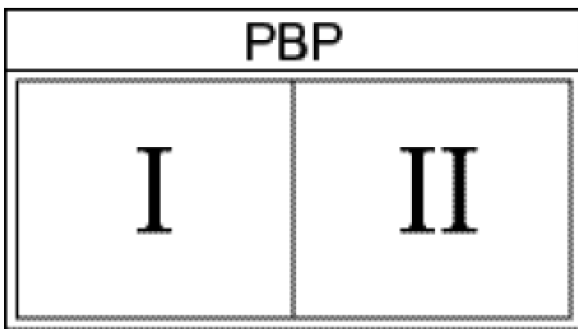
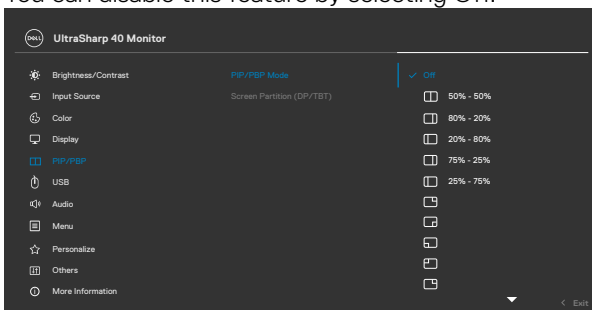

Icon	Menu and Submenus	Description
------	-------------------	-------------

PIP/PBP (Sub) Select between the different video signals that may be connected to your monitor for the PBP sub-window. Press the  button to select the PBP sub-window source signal.

NOTE: The feature is available only when the PIP/PBP mode is enabled.

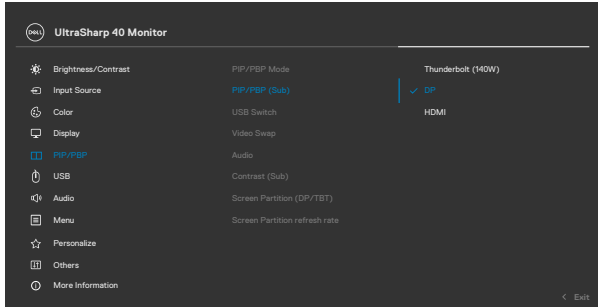

USB Switch Select to switch between the USB upstream sources in PBP mode. Move the joystick to switch among USB upstream sources in PBP mode.

NOTE: The feature is available only when the PIP/PBP mode is enabled.

Video Swap Select to swap videos between the main window and sub-window in PBP mode. Move the joystick to swap the main window and sub-window.

NOTE: The feature is available only when the PIP/PBP mode is enabled.

Audio Allows you to set the audio source from the main window or the sub-window.

NOTE: The feature is available only when the PIP/PBP mode is enabled.

Contrast (Sub) Adjust the **Contrast** level of the picture in PBP Mode. Move the Joystick to increase or decrease the contrast.

NOTE: The feature is available only when the PIP/PBP mode is enabled.



Icon	Menu and Submenus	Description
------	-------------------	-------------

Screen Partition (DP/TBT)

To enable dual screen and select the preferred partition ratio with one TBT/DP cable only.

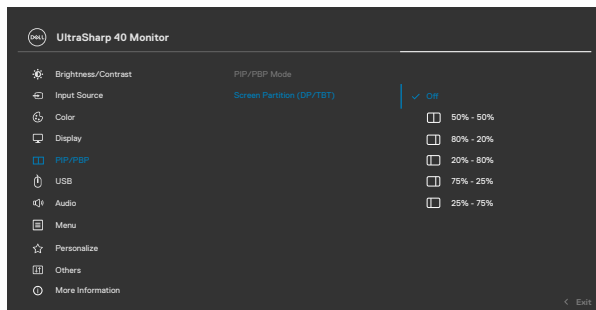

Screen Partition refresh rate

Screen Partition refresh rate for 60Hz/120Hz.

NOTE: The feature is available only when the Screen partition (DP/TBT) is enabled.

NOTE: Select 60Hz only when there is problem in setting up two partition.

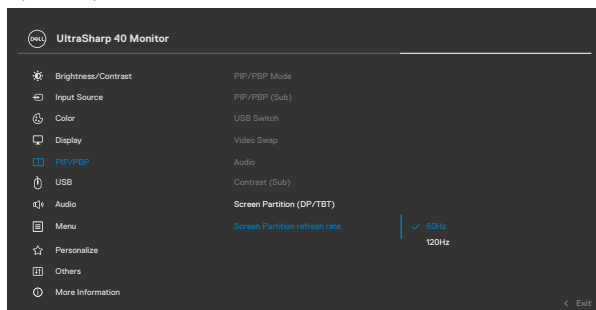

Icon	Menu and Submenus	Description
------	-------------------	-------------



USB

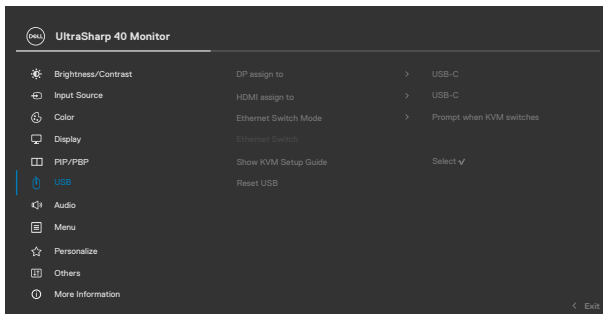

Allow you to pair the Video input port to the USB upstream port. So that the USB downstream devices, for example, keyboard and mouse are assigned and can be used with the active video.



NOTE: For DP and HDMI video, connect the Computer USB-A port to Monitor USB-C upstream port with the USB A-C cable. There is no additional USB cable needed for Thunderbolt™ video.

NOTE: To prevent data damage or loss, before changing USB upstream ports, make sure that No USB storage devices are in use by the computer connected to the monitor's USB upstream port.

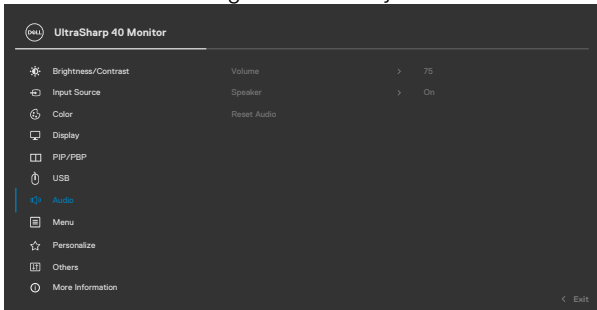

Icon	Menu and Submenus	Description
	Ethernet Switch Mode	Allows you to set the Ethernet switch mode: <ul style="list-style-type: none"> • Tie to KVM: When KVM USB switches, Ethernet switches together. • Prompt when KVM switches: When KVM USB switches, a message prompts the user to decide whether to switch Ethernet together. • Switch Manually: When KVM USB switches, Ethernet does not switch.
	Ethernet Switch	Manually switch Ethernet.
	Show KVM Setup Guide	Select this option and follow the steps if you want to connect multiple computers to the monitor with one set of keyboard and mouse.
	Reset USB	Resets all settings under the USB menu to the factory defaults.
	Audio	Use the Audio Settings menu to adjust the audio settings.
		
		
	Volume	Allows you to increase the speaker volume. Move the joystick up and down to adjust the volume from '0' to '100'.
	Speaker	Select On or Off the Speaker function.
	Reset Audio	Resets all settings under the Audio menu to the factory preset values.



Icon	Menu and Submenus	Description
------	-------------------	-------------



Menu

Select this option to adjust the settings of the OSD, such as the languages of the OSD, the amount of time the menu remains on screen, and so on.

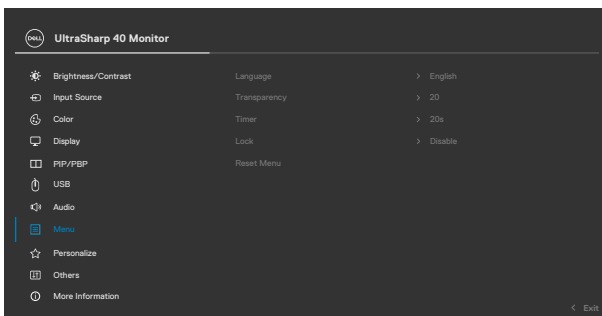

Language

Set the OSD display to one of eight languages. (English, Spanish, French, German, Brazilian Portuguese, Russian, Simplified Chinese, or Japanese).

NOTE: The function is disabled when **Menu Voice** is **On**.

Transparency

Select this option to change the menu transparency by moving the Joystick up or down (Range: 0-100).

Timer

OSD Hold Time: Sets the length of time the OSD remains active after you press a button.

Move the joystick to adjust the slider in 1-second increments, from 5-60 seconds.



Icon	Menu and Submenus	Description
	Lock	<p>With the control buttons on the monitor locked, you can prevent people from accessing the controls. It also prevents accidental activation in multiple monitors side-by-side setup.</p> <p>NOTE: The function will be disabled when Menu Voice is On.</p>

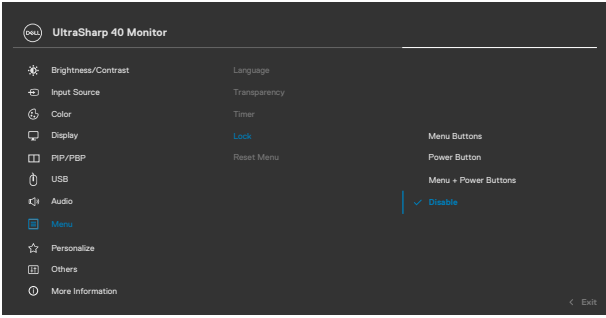

- ◆ **Menu Buttons:** Through OSD to lock the Menu buttons.
- ◆ **Power Button:** Through OSD to lock the Power button.
- ◆ **Menu + Power Buttons:** Through OSD to lock all Menu and Power buttons.
- ◆ **Disable:** Move the Joystick left and hold for 4 seconds.

Reset Menu Resets all settings under the **Reset Menu** to the factory defaults.

Press  to select this function.



Icon	Menu and Submenus	Description
------	-------------------	-------------



Personalize

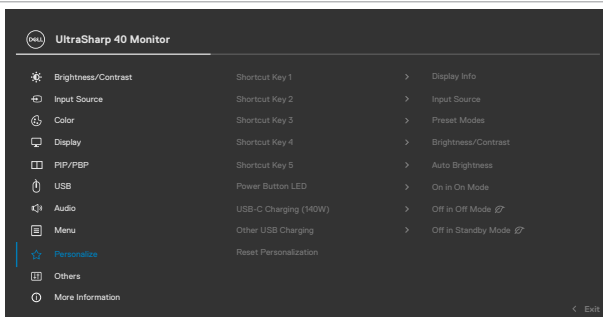

Shortcut key 1	Select from Preset Modes, Brightness/Contrast, Auto Brightness, Auto Color Temp., Input Source, Aspect Ratio, Volume, Speaker, PIP/PBP Mode, USB Switch, Ethernet Switch, Video Swap, Smart HDR, Display Info, or Screen Partition and set as shortcut key.
Shortcut key 2	
Shortcut key 3	
Shortcut key 4	
Shortcut key 5	
Power Button LED	Allows you to set the state of the power light to save energy.
USB-C Charging (140W)	Allows you to enable or disable USB-C Charging (140W) charging function during monitor power off mode. NOTE: When this function is enabled, you can charge your notebook or mobile devices through the Thunderbolt™ cable even when the monitor is powered Off.
Other USB Charging	Allows you to enable or disable Other USB Charging function during monitor Standby mode. NOTE: When this function is enabled, you can charge your mobile devices through the USB-A, USB-C®, and Thunderbolt™ downstream port with the appropriate cable even when the monitor is in standby mode.
Reset Personalization	Resets all settings under the Personalize to the factory defaults. Press to select this function.



Icon **Menu and Submenus**

Description



Others

Select this option to adjust the OSD settings such as the **DDC/CI**, **LCD** conditioning, and so on.

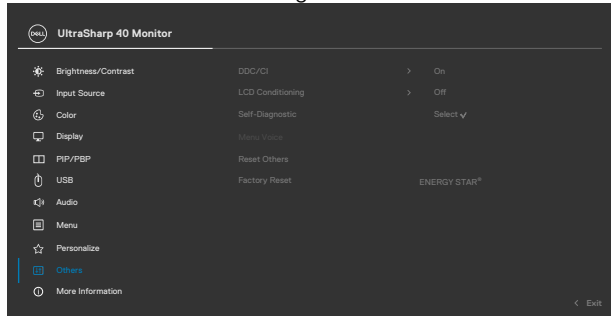

DDC/CI

DDC/CI (Display Data Channel/Command Interface) allows your monitor parameters (brightness, color balance, so on.) to be adjustable over the software on your computer. You can disable this feature by selecting **Off**. Enable this feature for the best user experience and optimum performance of your monitor.

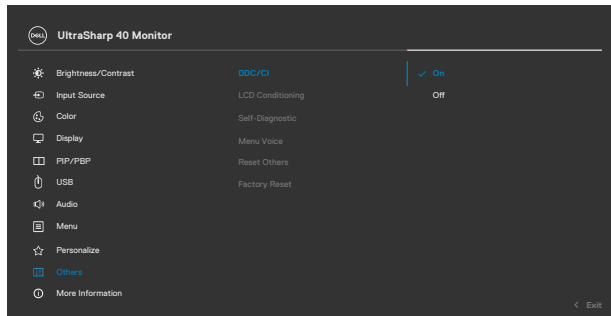

Icon	Menu and Submenus	Description
------	-------------------	-------------

LCD Conditioning

Helps reduce minor cases of image retention. Depending on the degree of image retention, the program may take some time to run. You can enable this feature by selecting **On**.

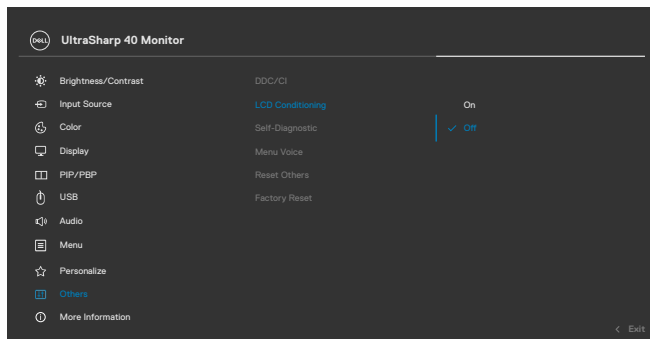

Self-Diagnostic Use this option to run the built-in diagnostics, see **Built-in Diagnostics**.

Menu Voice This is an accessibility feature for people who are visually impaired. You can enable this feature by selecting **On** after plug-in CVAA. See **Enable Menu Voice Function**.

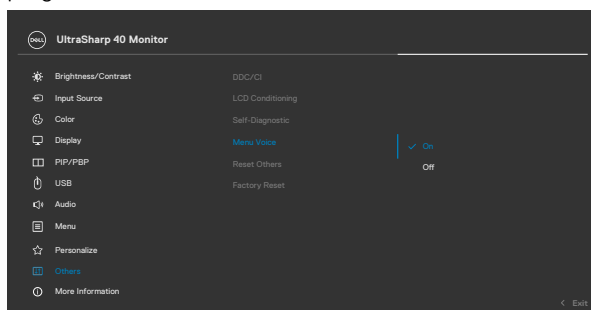

Icon	Menu and Submenus	Description
	Reset Others	Resets all settings under the Others menu to the factory defaults. Press  to select this function.
	Factory Reset	Restores all preset values to the factory default settings. These are also the settings for ENERGY STAR® tests.



More Information

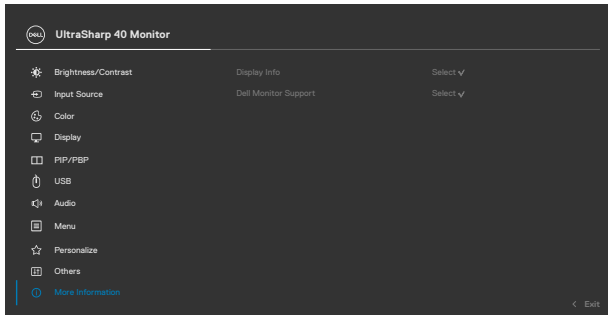

Display Info

Displays the monitor's current settings.
Press  to select this function.

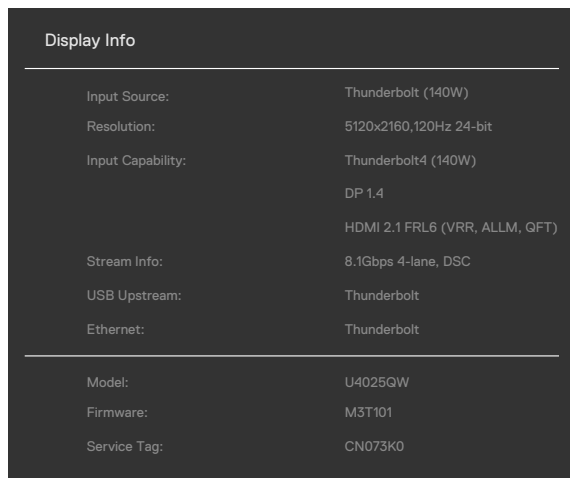

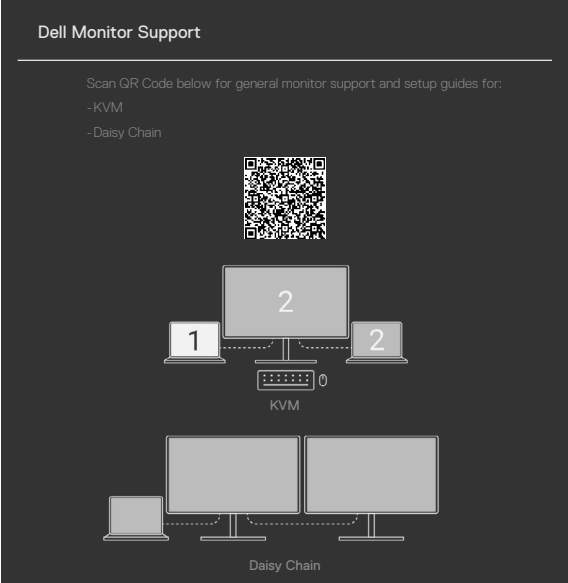
Icon	Menu and Submenus	Description
	Dell Monitor Support	To access the general monitor support materials for your monitor, use your smartphone to scan the QR code. 



Using the OSD lock function

You can lock the front-panel control buttons to prevent access to the OSD menu and/or power button.

Use the Lock menu to lock the buttons.

1. Select one of the following options.

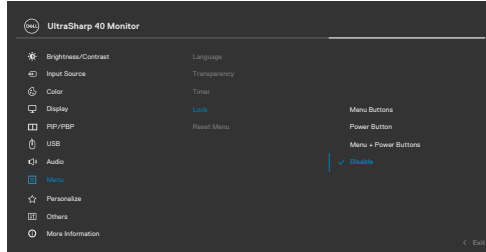

2. The following message appears.

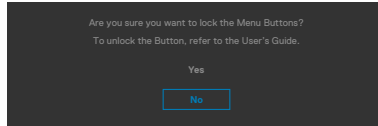

3. Select **Yes** to lock buttons. Once locked, pressing any control button displays the lock icon .



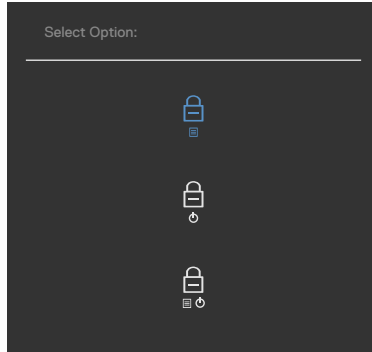

Use the Joystick to lock the buttons.

Press the left directional navigation of Joystick for four seconds, and a menu appears on the screen.



Select one of the following options:



Options	Description
1  Menu button lock	Select this option to lock the OSD menu function.
2  Power button lock	Use this option to lock power button. This prevents the user to turn off the monitor using the power button.
3  Menu and power button lock	Use this option to lock the OSD menu and power button to turn off the monitor.

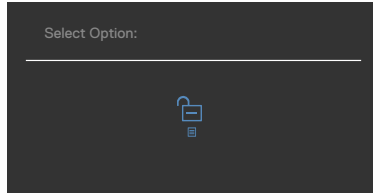

To unlock the buttons.

Press the left directional navigation of Joystick for four seconds until a menu appears on the screen. The following table describes the options to unlock the front-panel control buttons.



Options	Description
1  Menu button unlock	Use this option to unlock OSD menu function.
2  Power button unlock	Use this option to unlock power button to turn off the monitor.
3  Menu and power button unlock	Use this option to unlock the OSD menu and the power button to turn off the monitor.



Initial Setup

When you select OSD items of **Factory Reset** in Other feature, the following message appears:

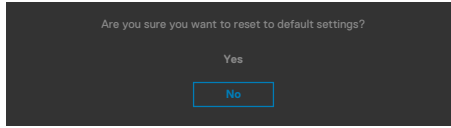

When you select **Yes** to reset to default settings, the following message appears:

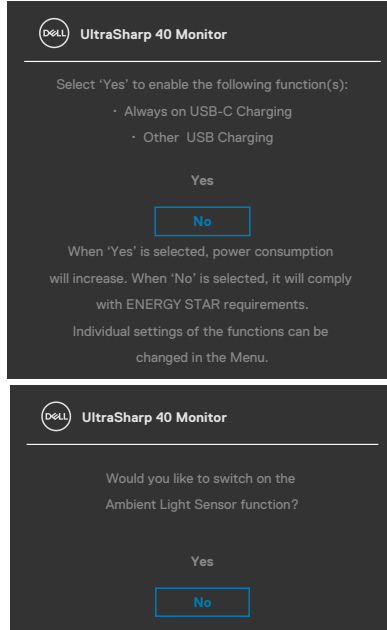

OSD warning messages

When the monitor does not support a particular resolution mode, you can see the following message:

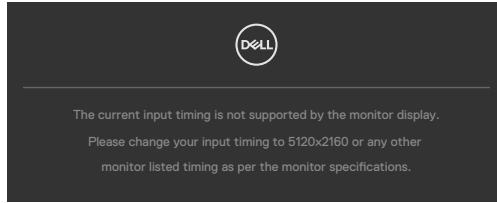

The above message explains that the monitor cannot synchronize with the signal that it is receiving from the computer. See [Monitor Specifications](#) for the Horizontal and Vertical frequency ranges addressable by this monitor. The recommended mode is **5120 x 2160**.

You can see the following message before the DDC/CI function is disabled:

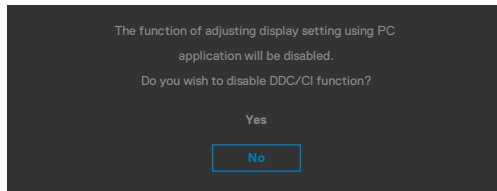

When the monitor enters the **Standby Mode**, the following message appears:

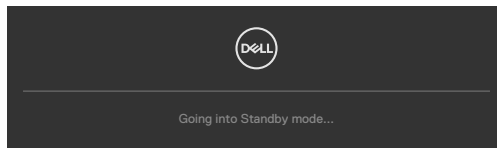

Activate the computer and wake up the monitor to gain access to the **OSD**.

If you press any button other than the power button, the following messages appears depending on the selected input:

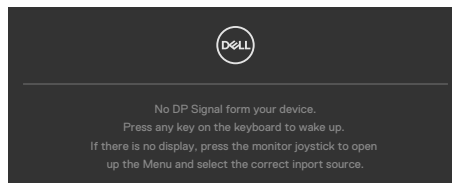

A message is displayed while the cable supporting DP alternate mode is connected to the monitor under the following conditions:

- When Auto Select for **Thunderbolt(140W)** is set to **Prompt for Multiple Inputs**.
- When the Thunderbolt™ cable is connected to the monitor.

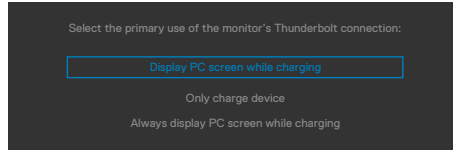

If two or more ports are connected, when the **Auto** of Input Source is selected, it will turn to the next port with signal.

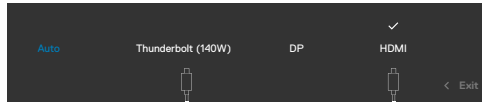

Select OSD items of **On in Standby Mode** in the Personalize feature, the following message appears:

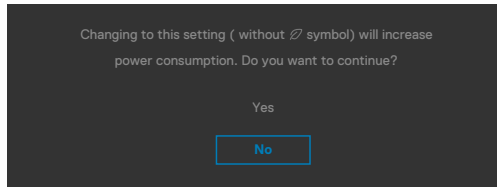

If adjust the Brightness level above the default level over 75%, the following message will appear:

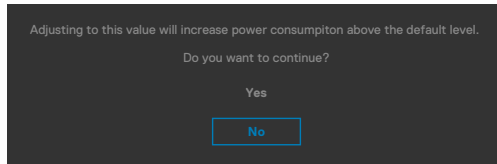

- When you select **Yes**, the power message is displayed only once.
- When you select **No**, the power warning message appears again.
- The power warning message appears again only when the user does a Factory Reset from the OSD menu.



If either DP/HDMI/Thunderbolt (140W) input is selected and the corresponding cable is not connected, a floating dialog box as shown below appears.

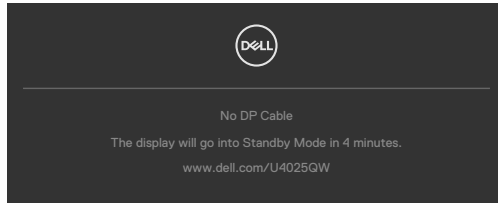

or

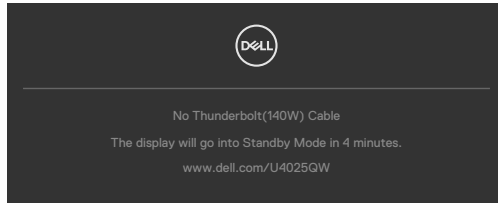

or

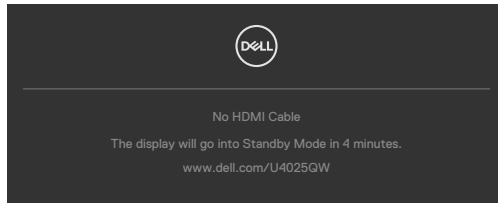

See [Troubleshooting](#) for more information.



Setting the maximum resolution

 **NOTE: The steps may vary slightly depending on the version of Windows you have.**

To set the maximum resolution for the monitor:

In Windows 10 and Windows 11:

1. Right-click the desktop and click **Display Settings**.
2. If you have more than one monitor connected, ensure that you select **U4025QW**.
3. Click the **Display Resolution** dropdown list and select **5120 x 2160**.
4. Click **Keep changes**.

If you do not see **5120 x 2160** as an option, you must update your graphics driver to the latest version. Depending on your computer, complete one of the following procedures:

If you have a Dell desktop or laptop:

- Go to <https://www.dell.com/support>, enter your service tag, and download the latest driver for your graphics card.

If you are using a non-Dell computer (laptop or desktop):

- Go to the support site for your computer and download the latest graphic drivers.
- Go to your graphics card website and download the latest graphic drivers.



Troubleshooting

⚠ WARNING: Before you begin any of the procedures in this section, follow the [Safety Instructions](#).

Self-test

Your monitor provides a self-test feature that allows you to check whether your monitor is functioning properly. If your monitor and computer are properly connected but the monitor screen remains dark, run the monitor self-test by performing the following steps:

1. Turn off both your computer and the monitor.
2. Unplug the video cable from the back of the computer. To ensure proper Self-Test operation, remove all digital and the analog cables from the back of the computer.
3. Turn on the monitor.

The floating dialog box should appear on-screen (against a black background), if the monitor cannot sense a video signal and is working correctly. While in self-test mode, the power LED remains white. Also, depending upon the selected input, one of the dialogs that are shown below will continuously scroll through the screen.

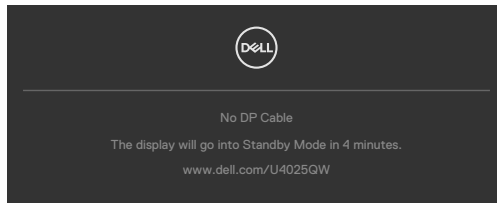

or

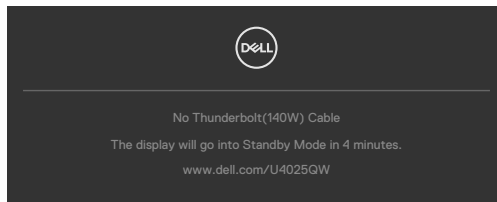

4. This message also appears during normal system operation if the video cable is disconnected or damaged.
5. Turn off your monitor and reconnect the video cable; then turn on both your computer and the monitor.

If your monitor screen remains blank after you use the previous procedure, check your video controller and computer, because your monitor is functioning properly.



Built-in diagnostics

Your monitor has a built-in diagnostic tool that helps you determine if the screen abnormality you are experiencing is an inherent problem with your monitor, or with your computer and video card.

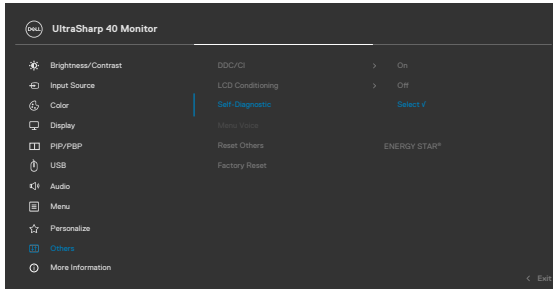

To run the built-in diagnostics:

1. Ensure that the screen is clean (no dust particles on the surface of the screen).
2. Select OSD items of Self-Diagnostics in Others feature.
3. Press the joystick button to start the diagnostics. A gray screen is displayed.
4. Observe if the screen has any defects or abnormalities.
5. Toggle the joystick once again until a red screen is displayed.
6. Observe if the screen has any defects or abnormalities.
7. Repeat steps 5 and 6 until the screen displays green, blue, black, and white colors. Note any abnormalities or defects.

The test is complete when a text screen is displayed. To exit, toggle the joystick control again.

If you do not detect any screen abnormalities upon using the built-in diagnostic tool, the monitor is functioning properly. Check the video card and computer.



Common Problems

The following table contains general information about common monitor problems that you might encounter and the possible solutions:

Common Symptoms	What you experience	Possible solutions
No video/power LED off	No picture	<ul style="list-style-type: none">• Ensure that the video cable connecting the monitor and the computer is properly connected and secure.• Verify that the power outlet is functioning properly using any other electrical equipment.• Ensure that the power button is pressed fully.• Ensure that the correct input source is selected in the Input Source menu.
No video/power LED on	No picture or no brightness	<ul style="list-style-type: none">• Increase brightness and contrast controls using OSD.• Perform monitor self-test feature check.• Check for bent or broken pins in the video cable connector.• Run the built-in diagnostics.• Ensure that the correct input source is selected in the Input Source menu.
Missing pixels	LCD screen has spots	<ul style="list-style-type: none">• Cycle power on-off.• A pixel that is permanently off is a natural defect that can occur in LCD technology.• For more information about Dell Monitor Quality and Pixel Policy, see Dell Support site at: https://www.dell.com/pixelguidelines.
Stuck-on pixels	LCD screen has bright spots	<ul style="list-style-type: none">• Cycle power on-off.• A pixel that is permanently off is a natural defect that can occur in LCD technology.• For more information about Dell Monitor Quality and Pixel Policy, see Dell Support site at: https://www.dell.com/pixelguidelines.
Brightness problems	Picture too dim or too bright	<ul style="list-style-type: none">• Reset the monitor to factory settings.• Adjust brightness and contrast controls using OSD.



Common Symptoms	What you experience	Possible solutions
Safety-related issues	Visible signs of smoke or sparks	<ul style="list-style-type: none"> Do not perform any troubleshooting steps. Contact Dell immediately.
Intermittent problems	Monitor malfunctions on and off	<ul style="list-style-type: none"> Ensure that the video cable connecting the monitor to the computer is connected properly and is secure. Reset the monitor to factory settings. Perform a monitor self-test feature check to determine if the intermittent problem occurs in self-test mode.
Missing color	Picture missing color	<ul style="list-style-type: none"> Perform monitor self-test. Ensure that the video cable connecting the monitor to the computer is connected properly and is secure. Check for bent or broken pins in the video cable connector.
Wrong color	Picture color is not good	<ul style="list-style-type: none"> Change the settings of the Preset Modes in the Color menu OSD depending on the application. Adjust R/G/B value under Custom Color in the Color menu OSD. Change the Input Color Format to PC RGB or YPbPr in the Color menu OSD. Run the built-in diagnostics.
Image retention from a static image left on the monitor for a long period of time	A faint shadow from the static image that is displayed appears on the screen	<ul style="list-style-type: none"> Set the screen to turn off after a few minutes of screen idle time. These can be adjusted in the Windows Power Options or Mac Energy Saver setting. Alternatively, use a dynamically changing screensaver.
TBT out cannot display	TBT out port connect the 2nd Monitor cannot display, but the display setting can recognize 2 monitor	<ul style="list-style-type: none"> Make sure the OSD Thunderbolt Daisy Chain is "Optimized". Open the display setting in NB/PC, if you can see NB/PC and 1st monitor, select 2nd only, the 2nd monitor should be display.



Common Symptoms	What you experience	Possible solutions
The monitor cannot detect signal connect with dock after AC/DC Off/On, cable unplug/ Plug	Connect the Dock USB-C® cable to the platform. Connect DUT with TBT4 cable to the Dock USB-C® port. The monitor cannot detect the signal after AC Off/ On TBT4 cable Unplug/Plug	<ul style="list-style-type: none"> • Connect the monitor directly with the platform. • Change the TBT4 cable to a USB-C® cable.
The two monitor maximum resolution cannot reach 5120 x 2160 @ 120 Hz when TBT Daisy Chain	Connect 1st DUT with TBT4 cable to the platform. Connect 2nd DUT to the 1st DUT Thunderbolt™ out port with TBT4 cable. The 2nd monitor or 1st monitor cannot reach 5120 x 2160 @120 Hz	<ul style="list-style-type: none"> • Make sure the OSD Thunderbolt Daisy Chain is “Optimized”.
2nd monitor shows black screen when TBT daisy chain and enable SmartHDR on both OSD and Windows display setting	Connect 1st DUT with TBT4 cable to the platform. Connect 2nd DUT to the 1st DUT Thunderbolt™ out port with TBT4 cable. Set both DUT to the maximum resolution (5120 x 2160). Enable SmartHDR on both OSD and Windows display setting. 2nd monitor shows black screen	<ul style="list-style-type: none"> • Intel UHD graphic limitation, suggest to use Intel Iris graphic. • Disable SmartHDR on both OSD and Windows display setting.



Common Symptoms	What you experience	Possible solutions
Auto source cannot automatically switch to DP input source when you connect the DP cable to the platform	When you connect the HDMI cable and DP cable to monitor, connect HDMI cable to platform and display normally, then connect DP cable to platform. The signal cannot automatically to DP signal	<ul style="list-style-type: none">· Unplug and plug the DP cable from the monitor side.· Go to the OSD menu and enter input source select DP manually.



Product-specific problems

Problem	What you experience	Possible solutions
Screen image is too small	The image is centered on the screen, but does not fill the entire viewing area	<ul style="list-style-type: none">• Check the Aspect Ratio setting in the Display menu OSD.• Reset the monitor to factory settings.
Cannot adjust the monitor with the joystick control on the rear of the monitor	OSD does not appear on the screen	<ul style="list-style-type: none">• Turn off the monitor, unplug the monitor power cable, plug it back, and then turn on the monitor.
No Input Signal when user controls are pressed	No picture, the LED light is white	<ul style="list-style-type: none">• Check the signal source. Ensure that the computer is not in the power-saving mode by moving the mouse or pressing any key on the keyboard.• Check whether the signal cable is plugged in properly. Connect the signal cable again, if necessary.• Reset the computer or video player.
The picture does not fill the entire screen	The picture cannot fill the height or width of the screen	<ul style="list-style-type: none">• Due to different video formats (aspect ratio) of DVDs, the monitor may display in full screen.• Run the built-in diagnostics.
No image when using DP connection to the PC	Blank screen	<ul style="list-style-type: none">• Verify which DP standard is your Graphics card is certified to. Download and install the latest graphics card driver.
No image when using Thunderbolt™ 4 connection to computer, laptop, and so on	Blank screen	<ul style="list-style-type: none">• Verify if the Thunderbolt™ 4 interface of the device can support DP alternate mode.• Verify if the device required more than EPR 140W power charging.• Set Windows to Projection mode.• Ensure that the Thunderbolt™ 4 cable is not damaged.



Problem	What you experience	Possible solutions
No charging when using Thunderbolt™ 4 connection to computer, laptop, and so on	No charging	<ul style="list-style-type: none"> • Verify if the device can support one of the 5 V/9 V/15 V/20 V/28 V charging profiles. • Verify if the Notebook requires a >EPR 140W power adapter. • If the Notebook requires a >EPR 140W power adaptor, it may not charge with the Thunderbolt™ 4 connection. • Ensure that you use only the Dell approved adapter or the adapter that comes with the product. • Ensure that the Thunderbolt™ 4 cable is not damaged.
Intermittent charging when using Thunderbolt™ 4 connection to computer, laptop, and so on	Intermittent charging	<ul style="list-style-type: none"> • Check if the maximum power consumption of the device is over EPR 140 W. • Ensure that you use only the Dell approved adapter or the adapter that comes with the product. • Ensure that the Thunderbolt™ 4 cable is not damaged.
No network connection	Network dropped or Intermittent	<ul style="list-style-type: none"> • Do not toggle Off/On the power button when the network is connected, keeps the power button On.



Problem	What you experience	Possible solutions
The LAN port is not functioning	Operating system setting or cable connection issue	<ul style="list-style-type: none"> • Ensure that the latest BIOS and drivers for your computer are installed on your computer. • Ensure that the RealTek 2.5G Ethernet Controller is installed in the Windows Device Manager. • If your BIOS Setup has a LAN/GBE Enabled/Disabled option, make sure it is set to Enabled. • Ensure that the Ethernet cable is connected securely on the monitor and the hub/router/firewall. • Check the status LED of the Ethernet cable to confirm connectivity. Reconnect both ends of the Ethernet cable if the LED is not lit. • First power off the Computer and unplug the Thunderbolt™ 4 cable and power cord of the monitor. Then power on the computer, plug in the monitor power cord and Thunderbolt™ 4 cable.
The detected light level drops significantly	When the Ambient Light Sensor is on, the detected ambient light drops significantly	<ul style="list-style-type: none"> • Check whether an object is obstructing the sensor area. • Ensure that a webcam is not mounted over the sensor area. • Wipe clean any dust that may be covering the sensor area. • Ensure that the display is not pivoted and placed to another monitor side-by-side.



Universal Serial Bus (USB) specific problems

Specific Symptoms	What you experience	Possible solutions
USB interface is not working	USB peripherals are not working	<ul style="list-style-type: none">· Check that your display is turned ON.· Reconnect the upstream cable to your computer.· Reconnect the USB peripherals (downstream connector).· Turn off the monitor and turn it on again.· Reboot the computer.· Certain USB devices such as portable hard drives require higher power source; connect the drive to the computer directly.
SuperSpeed USB 3.2 Gen2 interface is slow.	SuperSpeed USB 3.2 Gen2 peripherals working slowly or not working at all	<ul style="list-style-type: none">· Check that your computer is USB 3.0-capable.· Some computers have USB 3.0, USB 2.0, and USB 1.1 ports. Ensure that the correct USB port is used.· Reconnect the upstream cable to your computer.· Reconnect the USB peripherals (downstream connector).· Reboot the computer.
Wireless USB peripherals stop working when a USB 3.0 device is plugged in	Wireless USB peripherals responding slowly or only working as the distance between itself and its receiver decreases	<ul style="list-style-type: none">· Increase the distance between the USB 3.0 peripherals and the wireless USB receiver.· Position your wireless USB receiver as close as possible to the wireless USB peripherals.· Use a USB-extender cable to position the wireless USB receiver as far away as possible from the USB 3.0 port.



Regulatory information

FCC notices (U.S. only) and other regulatory information

For FCC notices and other regulatory information, see the regulatory compliance at https://www.dell.com/regulatory_compliance.



EU product database for energy label and product information sheet

U4025QW: <https://eprel.ec.europa.eu/qr/1821612>



Contacting Dell

To contact Dell for sales, technical support, or customer service issues, see www.dell.com/contactdell.

-  **NOTE: Availability varies by country and product, and some services may not be available in your country.**
-  **NOTE: If you do not have an active internet connection, you can find contact information on your purchase invoice, packing slip, bill, or Dell product catalog.**

